



Specifically designed for smaller compressed air applications (up to 70 scfm) with a low condensate flow, the AOWS-70 Condensate Separator is a simple and cost effective way to meet environmental regulations for condensate disposal.

With an advanced polypropylene adsorbent media, the AOWS-70 can separate virtually any condensate containing any compressor lubricant\* discharged from any type of condensate drain, and it does so without the need for a condensate settling tank or storage chamber.

Simply mount it to the wall, connect the inlet and outlet and enjoy the benefits of clean condensate. When it's full of oil - just replace it.

\* Contact us for sizing assistance with PAG lubricant applications.

FEATURES	BENEFITS
Wall mounting kit included	Easy to install. No floor space required.
Brass inlet & outlet ports	For secure threaded or tubing connections.
Foam depressurization layer	Separates condensate & compressed air.
Polypropylene media	Adsorbs compressor oil.
Carbon polishing media	Filters out any remaining hydrocarbons.
Simple replaceable design	Just remove and replace it when it's full.
Rugged ABS housing	Lightweight, yet strong and durable.
No settling chamber	Perfect for portable applications.

**SIMPLE EFFECTIVE CONDENSATE TREATMENT**

# AOWS-70

## Technical Specifications



Wall mounting kit included



Brass inlet connection



Brass outlet connection

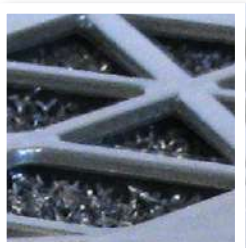

Depressurization layer

Maximum Compressor Capacity		70 scfm
Maximum Oil Adsorption Capacity		0.5 gal
Inlet Connections	Quantity	1
	Size	1/2 in
	Material	Brass
	Type	Threaded (NPT) or Hose
Outlet Connections	Quantity	1
	Size	1/2 in
	Material	Brass
	Type	Threaded (NPT) or Hose
Weight		8 lbs
Housing Material		ABS

\* Contact us for sizing assistance with PAG lubricant applications.

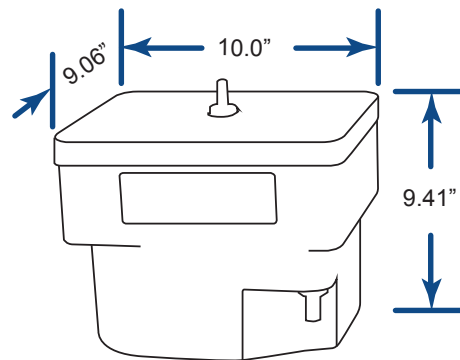

Perfect for installations with:

- Low compressed air flows
- Low condensate flows
- Portable applications
- Any type of compressor oil\*
- Emulsified mixtures
- Any type of condensate drain
- EPA discharge regulations
- Operating cost concerns

*Information provided herewith is believed to be accurate and reliable. However, no responsibility is assumed for its use or for any infringement of patents or rights of others, which may result from its use. In addition, the manufacture reserves the right to revise information without notice and without incurring any obligation.*



Specifically designed for compressed air applications from 75 to 125 scfm, the AOWS-125 Condensate Separator is a simple and cost effective way to meet environmental regulations for condensate disposal.

With an advanced polypropylene adsorbent media and a carbon polisher, the AOWS-125 can separate virtually any condensate containing any compressor lubricant\* discharged from any type of condensate drain, and it does so without the need for a condensate settling tank or storage chamber.

AOWS Condensate Separators are the most cost effective and reliable solution to meet environmental regulations for condensate treatment.

*\* Contact us for sizing assistance with PAG lubricant applications.*

FEATURES	BENEFITS
No settling chamber or storage tank required	Eliminates health & safety concerns. Performance is not affected by movement.
Can separate any type of lubricant	Including modern synthetic lubricants* or even emulsified mixtures.
Can be used with any type of drain	Including all Aircel condensate drains.
Brass threaded inserts & adapters	For secure inlet and outlet piping or tubing connections.
Foam mesh depressurization chamber with foam exhaust filter	Slows incoming condensate and cleanly discharges compressed air.
Three stages of treatment	Two polypropylene elements and a carbon polisher for optimum performance.
Multiple lightweight media bags	Comply with OSHA lifting requirements
Rugged polyethylene housing	Strong and corrosion proof construction.
Wall mounting kit optional	Easy to install. No floor space required.

**SIMPLE EFFECTIVE CONDENSATE TREATMENT**

# AOWS-125

## Technical Specifications

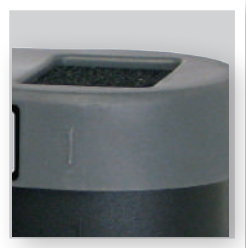

Depressurization chamber



Test port and kit included



Compact design



Two treatment elements

Maximum Compressor Capacity		125 scfm
Maximum Oil Adsorption Capacity		0.8 gal
Inlet Connections	Quantity	1
	Size	1/2 in
	Material	Brass
	Type	Threaded (NPT) or Hose
Outlet Connections	Quantity	1
	Size	1/2 in
	Material	Brass
	Type	Threaded (NPT) or Hose
Weight		18 lbs
Housing Material		Polyethylene

\* Contact us for sizing assistance with PAG lubricant applications.

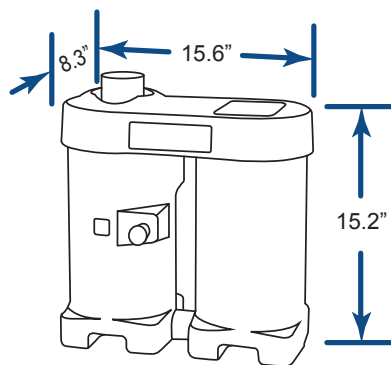

Perfect for installations with:

- Portable applications
- Any type of compressor oil\*
- Emulsified mixtures
- Any type of condensate drain
- Portable applications
- Floor space restrictions
- EPA discharge regulations
- Operating cost concerns

*Information provided herewith is believed to be accurate and reliable. However, no responsibility is assumed for its use or for any infringement of patents or rights of others, which may result from its use. In addition, the manufacture reserves the right to revise information without notice and without incurring any obligation.*



The AOWS-350 Condensate Separator uses three stages of treatment to separate difficult condensate. With two specially treated polypropylene elements and a carbon polisher, you can count on reliable and cost effective condensate separation performance regardless of the type of lubricant\* or drains you use.

This model is loaded with useful features, like a visual element life indicator that lets you know when your elements need to be replaced, and an overflow indicator to avoid messy spills.

Take the guesswork out of condensate treatment and upgrade to the AOWS Condensate Separator.

*\* Contact us for sizing assistance with PAG lubricant applications.*

FEATURES	BENEFITS
No settling chamber or storage tank required	Eliminates health & safety concerns. Performance is not affected by movement.
Can separate any type of lubricant	Including modern synthetic lubricants* or even emulsified mixtures.
Can be used with any type of drain	Including all Aircel condensate drains.
Brass threaded inserts & adapters	For secure inlet and outlet piping or tubing connections.
Foam mesh depressurization chamber with foam exhaust filter	Slows incoming condensate and cleanly discharges compressed air.
Visual element life indicator	Provides confident indication of element condition.
Overflow warning indicator	Avoids spills in the event of a blockage.
Three stages of treatment	Two polypropylene elements and a carbon polisher for optimum performance.
Multiple lightweight media bags	Comply with OSHA lifting requirements.
Rugged polyethylene housing	Strong and corrosion proof construction.

**SIMPLE EFFECTIVE CONDENSATE TREATMENT**

# AOWS-350

## Technical Specifications



Depressurization chamber

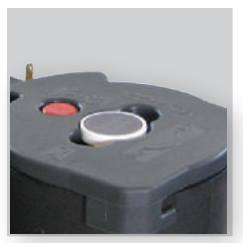

Sample bottle included



Polypropylene elements



Carbon polishing element

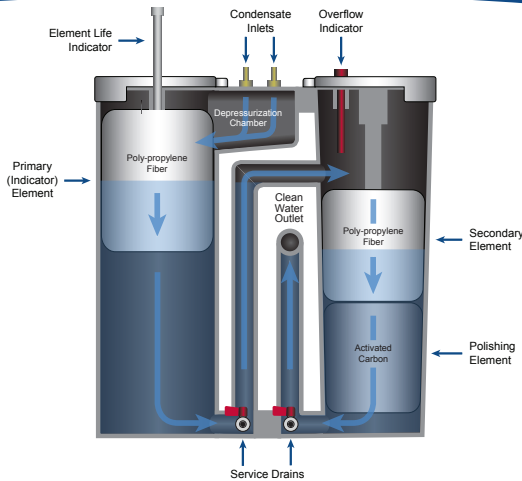

Maximum Compressor Capacity		350 scfm
Maximum Oil Adsorption Capacity		2.6 gal
Service Drains		2
Inlet Connections	Quantity	2
	Size	1/2 in
	Material	Brass
	Type	Threaded (NPT) or Hose
Outlet Connections	Quantity	1
	Size	1 in
	Material	Brass
	Type	Threaded (NPT) or Hose
Weight		39 lbs
Housing Material		Polyethylene

\* Contact us for larger, 24/7, or specialized applications, or for sizing assistance when using PAG lubricants.

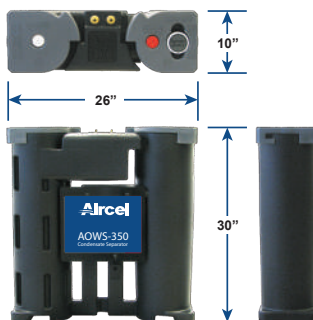

Perfect for installations with:

- High air or condensate flows
- Any type of oil\* or drain
- Emulsified mixtures
- Portable applications
- Floor space restrictions
- Operating cost concerns

*Information provided herewith is believed to be accurate and reliable. However, no responsibility is assumed for its use or for any infringement of patents or rights of others, which may result from its use. In addition, the manufacture reserves the right to revise information without notice and without incurring any obligation.*



The AOWS-750 Condensate Separator uses three stages of treatment to separate difficult condensate. With two specially treated polypropylene elements and a carbon polisher, you can count on reliable and cost effective condensate separation performance regardless of the type of lubricant\* or drains you use.

This model is loaded with useful features, like a visual element life indicator that lets you know when your elements need to be replaced, and an overflow indicator to avoid messy spills.

Take the guesswork out of condensate treatment and upgrade to the AOWS Condensate Separator.

*\* Contact us for sizing assistance with PAG lubricant applications.*

FEATURES	BENEFITS
No settling chamber or storage tank required	Eliminates health & safety concerns. Performance is not affected by movement.
Can separate any type of lubricant	Including modern synthetic lubricants* or even emulsified mixtures.
Can be used with any type of drain	Including all Aircel condensate drains.
Brass threaded inserts & adapters	For secure inlet and outlet piping or tubing connections.
Foam mesh depressurization chamber with foam exhaust filter	Slows incoming condensate and cleanly discharges compressed air.
Visual element life indicator	Provides confident indication of element condition.
Overflow warning indicator	Avoids spills in the event of a blockage.
Three stages of treatment	Two polypropylene elements and a carbon polisher for optimum performance.
Multiple lightweight media bags	Comply with OSHA lifting requirements.
Rugged polyethylene housing	Strong and corrosion proof construction.

**SIMPLE EFFECTIVE CONDENSATE TREATMENT**

# AOWS-750

## Technical Specifications

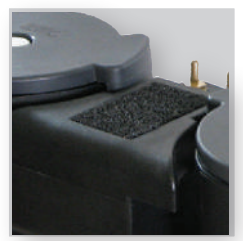

Depressurization chamber

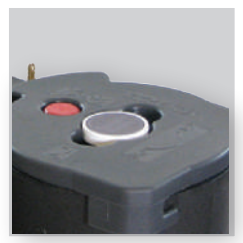

Sample bottle included



Polypropylene elements



Carbon polishing element

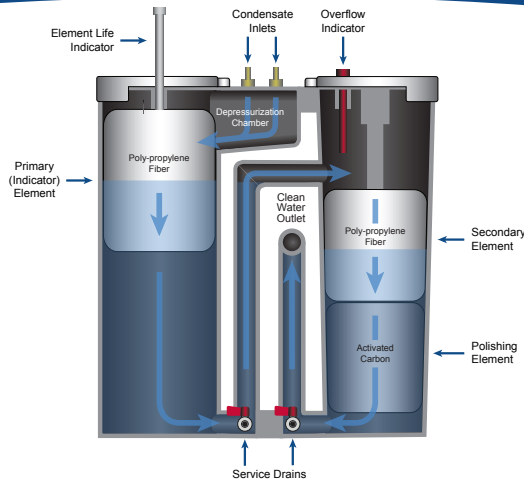

Maximum Compressor Capacity		750 scfm
Maximum Oil Adsorption Capacity		4.0 gal
Service Drains		2
Inlet Connections	Quantity	2
	Size	1/2 in
	Material	Brass
	Type	Threaded (NPT) or Hose
Outlet Connections	Quantity	1
	Size	1 in
	Material	Brass
	Type	Threaded (NPT) or Hose
Weight		72 lbs
Housing Material		Polyethylene

\* Contact us for larger, 24/7, or specialized applications, or for sizing assistance when using PAG lubricants.



Perfect for installations with:

- High air or condensate flows
- Any type of oil\* or drain
- Emulsified mixtures
- Portable applications
- Floor space restrictions
- Operating cost concerns

Information provided herewith is believed to be accurate and reliable. However, no responsibility is assumed for its use or for any infringement of patents or rights of others, which may result from its use. In addition, the manufacture reserves the right to revise information without notice and without incurring any obligation.





The AOWS-1250 Condensate Separator uses three stages of treatment to separate difficult condensate. With two specially treated polypropylene elements and a carbon polisher, you can count on reliable and cost effective condensate separation performance regardless of the type of lubricant\* or drains you use.

This model is loaded with useful features, like a visual element life indicator that lets you know when your elements need to be replaced, and an overflow indicator to avoid messy spills.

Take the guesswork out of condensate treatment and upgrade to the AOWS Condensate Separator.

*\* Contact us for sizing assistance with PAG lubricant applications.*

FEATURES	BENEFITS
No settling chamber or storage tank required	Eliminates health & safety concerns. Performance is not affected by movement.
Can separate any type of lubricant	Including modern synthetic lubricants* or even emulsified mixtures.
Can be used with any type of drain	Including all Aircel condensate drains.
Brass threaded inserts & adapters	For secure inlet and outlet piping or tubing connections.
Foam mesh depressurization chamber with foam exhaust filter	Slows incoming condensate and cleanly discharges compressed air.
Visual element life indicator	Provides confident indication of element condition.
Overflow warning indicator	Avoids spills in the event of a blockage.
Three stages of treatment	Two polypropylene elements and a carbon polisher for optimum performance.
Multiple lightweight media bags	Comply with OSHA lifting requirements.
Rugged polyethylene housing	Strong and corrosion proof construction.

**SIMPLE EFFECTIVE CONDENSATE TREATMENT**

# AOWS-1250

## Technical Specifications

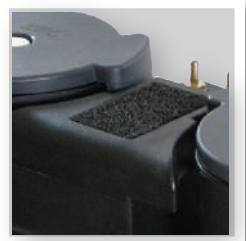

Depressurization chamber

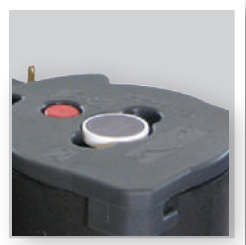

Sample bottle included



Polypropylene elements



Carbon polishing element

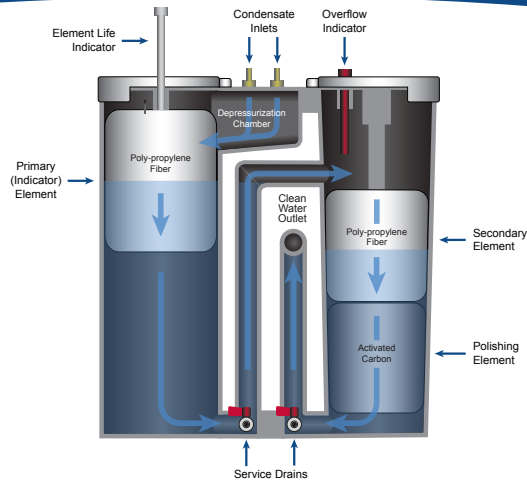

Maximum Compressor Capacity		1250 scfm
Maximum Oil Adsorption Capacity		6.6 gal
Service Drains		2
Inlet Connections	Quantity	2
	Size	1/2 in
	Material	Brass
Outlet Connections	Type	Threaded (NPT) or Hose
	Quantity	1
	Size	1 in
Outlet Connections	Material	Brass
	Type	Threaded (NPT) or Hose
Weight		107 lbs
Housing Material		Polyethylene

\* Contact us for larger, 24/7, or specialized applications, or for sizing assistance when using PAG lubricants.

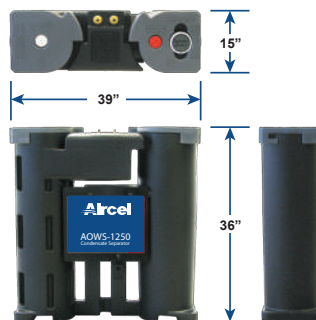

Perfect for installations with:

- High air or condensate flows
- Any type of oil\* or drain
- Emulsified mixtures
- Portable applications
- Floor space restrictions
- Operating cost concerns

*Information provided herewith is believed to be accurate and reliable. However, no responsibility is assumed for its use or for any infringement of patents or rights of others, which may result from its use. In addition, the manufacture reserves the right to revise information without notice and without incurring any obligation.*



The AOWS-3000 Condensate Separator is a simple and cost effective way to meet environmental regulations for condensate disposal.

With two polypropylene adsorbent media bags and a carbon polisher, the AOWS-3000 can separate virtually any condensate containing any compressor lubricant\* discharged from any type of condensate drain, and it does so without the need for a condensate settling tank or storage chamber. Mineral oil, semi or fully synthetic lubricants, even emulsifications are no problem for the AOWS-3000.

The AOWS-3000 converts virtually any condensate into clean water. It is the most cost effective and reliable solution to meet environmental regulations for condensate treatment.

*\* Contact us for sizing assistance with PAG lubricant applications.*

FEATURES	BENEFITS
No settling chamber or storage tank required	Eliminates health & safety concerns. Performance is not affected by movement.
Can separate any type of lubricant	Including modern synthetic lubricants* or even emulsified mixtures.
Can be used with any type of drain	Including all Aircel condensate drains.
Brass threaded inserts & adapters	For secure inlet and outlet piping or tubing connections.
Foam mesh depressurization chamber with foam exhaust filter	Slows incoming condensate and cleanly discharges compressed air.
Three stages of treatment	Two polypropylene elements and a carbon polisher for optimum performance.
Multiple lightweight media bags	Comply with OSHA lifting requirements.
Rugged polyethylene housing	Strong and corrosion proof construction.

**SIMPLE EFFECTIVE CONDENSATE TREATMENT**

# AOWS-3000

## Technical Specifications



Brass inserts and adapters



Test port and kit included



Multiple service ports



Easy media replacement



Maximum Compressor Capacity		3000 scfm
Maximum Oil Adsorption Capacity		14 gal
Inlet Connections	Quantity	4
	Size	1/2 in
	Material	Brass
	Type	Threaded (NPT) or Hose
Outlet Connections	Quantity	1
	Size	1/2 in
	Material	Brass
	Type	Threaded (NPT) or Hose
Weight		225 lbs
Housing Material		Polyethylene

\* Contact us for sizing assistance with PAG lubricant applications.

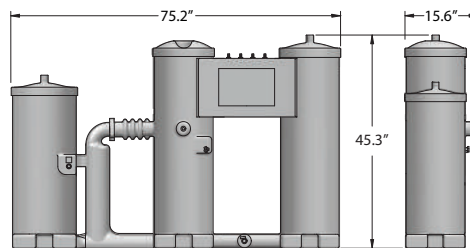

"S" Configuration

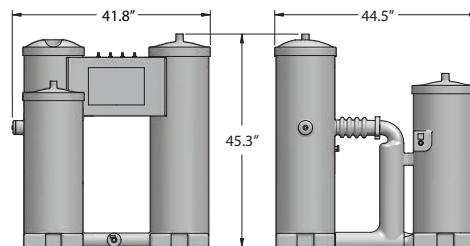

"L" Configuration

Perfect for installations with:

- High compressed air flows
- High condensate flows
- Difficult applications
- Any type of compressor oil\*
- Emulsified mixtures
- Any type of condensate drain
- EPA discharge regulations
- Operating cost concerns

*Information provided herewith is believed to be accurate and reliable. However, no responsibility is assumed for its use or for any infringement of patents or rights of others, which may result from its use. In addition, the manufacture reserves the right to revise information without notice and without incurring any obligation.*