

Air Amplifiers

Vent, exhaust, cool, dry, clean – with no moving parts!

What Are Air Amplifiers?

A simple, low cost way to move air, smoke, fumes, and light materials. Air Amplifiers utilize the Coanda effect, a basic principle of fluidics, to create air motion in their surroundings. Using a small amount of compressed air as their power source, Air Amplifiers pull in large volumes of surrounding air to **produce high volume, high velocity outlet flows**. **Quiet, efficient Air Amplifiers will create output flows up to 25 times their consumption rate.**

Why Air Amplifiers?

Air Amplifiers have no moving parts, assuring maintenance-free operation. No electricity is required. Flow, vacuum and velocity are easy to control. Outlet flows are easily adjusted by opening or closing the air gap. Supply air pressure can be regulated to fine tune outlet flow to meet application needs.

Both the vacuum and discharge ends of the Air Amplifier can be ducted, making them ideal for drawing fresh air from another location, or moving smoke and fumes away.



See page 4 for complete details.

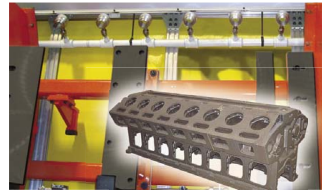

A series of Model 6042 2" (51mm) Adjustable Air Amplifiers blow coolant off 16 cylinder diesel engines.



Adjustable Air Amplifiers are ducted to draw clean air for drying.

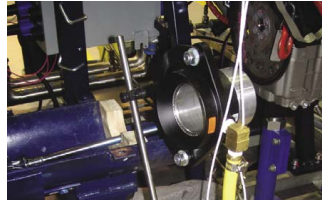

A Model 120024 4" (102mm) Super Air Amplifier cools an engine during dynamometer testing.

Applications

- Vent welding smoke
- Cool hot parts
- Dry wet parts
- Clean machined parts
- Distribute heat in molds/ovens
- Ventilate confined areas
- Dust collection
- Exhaust tank fumes

Advantages

Compared to Fans:

- Compact, lightweight, portable
- No electricity
- No moving parts – no maintenance
- Ends are easily ducted
- Instant on/off
- Variable force and flow
- No RF interference

Compared to Venturis and Ejectors:

- More air volume with lower compressed air consumption
- Higher flow amplification
- No internal obstructions
- Meets OSHA pressure and noise requirements
- Quiet

How Air Amplifiers Work

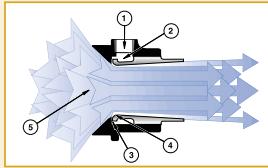

Compressed air flows through the air inlet (1) into an annular chamber (2). It is then throttled through a small ring nozzle (3) at high velocity. This primary airstream adheres to the Coanda profile (4), which directs it toward the outlet. A low pressure area is created at the center (5), inducing a high volume flow of surrounding air into the primary airstream. The combined flow of primary and surrounding air exhausts from the Air Amplifier in a high volume, high velocity flow.



A Model 121021 1-1/4" (32mm) High Temperature Air Amplifier directs hot air to a rotational mold cavity for uniform wall thickness of the plastic part.

Air Amplifiers

Air Amplifier Model Selection Guide

	Air Amplifier Comparison					
	Efficiency	Sound Level	Mounting Flange	Flow Adjustment	Temp. Rating	Corrosive Applications
Super Air Amplifier	High	Low	Yes	With Shims	275°F (135°C)	No
Aluminum Adjustable Air Amplifier	Medium	Variable	No	Infinite (No shims)	275°F (135°C)	No
Stainless Steel Adjustable Air Amplifier	Medium	Variable	No	Infinite (No shims)	400°F (204°C)	Yes
High Temperature Air Amplifier	High	Low	No	With Shims	700°F (374°C)	Yes

Special Air Amplifiers

EXAIR will manufacture special Air Amplifiers suited to your specific application requirements. The Model 121021 High Temperature Air Amplifier (*shown top right*) was developed for moving hot air to surfaces requiring uniform heating while in a furnace or oven. Modeled after our Super Air Amplifier, the High Temperature Air Amplifier is the most efficient for pushing high volumes of hot air to points that typically remain cool. This special design is rated for environments up to 700°F (374°C) and its surface is protected from heat stress by a mil-spec. coating process (developed for the aircraft industry), allowing easy disassembly for changing shims or cleaning.

Another stainless steel version for flange mounting was developed as a fan back-up for exhausting flue gases from a furnace (*shown middle right*). In the event of a power failure, this special Air Amplifier can quickly evacuate the fumes that could be harmful to workers close by.

A PTFE plug was used with a stainless steel Adjustable Air Amplifier (*shown bottom right*) to help pull a sticky material through a process and prevent the material from depositing on the Air Amplifier. EXAIR's Intelligent Compressed Air® products can be manufactured to your special requirements.

If you have special requirements, please contact an Application Engineer to discuss your application.



This special stainless steel flange-mount Air Amplifier was designed for exhausting hot flue gases from a furnace.



The airflow from this stainless steel Adjustable Air Amplifier with PTFE plug helped pull a sticky material through a process and prevented the material from depositing on the Air Amplifier.

Super Air Amplifier™

Powerful, efficient and quiet air mover for blowoff, cooling, and ventilation.



What Is The Super Air Amplifier?

EXAIR's Super Air Amplifier has a patented* design that uses a special shim to maintain critical position of the component parts. As a result, a precise amount of compressed air is released at exact intervals toward the center of the Super Air Amplifier. These jets of air create a constant, high velocity outlet flow across the entire cross-sectional area. Additional free air is pulled through the unit, resulting in higher amplification ratios. The balanced outlet airflow minimizes wind shear to produce sound levels that are typically three times quieter than other air movers.

Super Air Amplifiers are supplied with a .003" (0.08mm) slotted air gap which is ideal for most applications. Flow and force can be increased by replacing the shim with a thicker .006" (0.15mm) or .009" (0.23mm) shim. Model 120028 is supplied with a .009" (0.23mm) air gap. A .015" (0.39mm) shim is available for Model 120028.

Super Air Amplifier Performance at 80 PSIG (5.5 BAR)

MODEL	Air Consumption		Amplification RATIO	Air Volume at Outlet		Air Volume at 6" (152mm)		Sound Level dBA
	SCFM	SLPM		SCFM	SLPM	SCFM	SLPM	
120020	6.1	173	12	73	2,066	219	6,198	69
120021	8.1	229	18	146	4,132	436	12,339	72
120022	15.5	439	22	341	9,650	1,023	28,951	72
120024	29.2	826	25	730	20,659	2,190	61,977	73
120028	120	3,396	25	3,000	84,900	9,000	254,700	88

Model 120028 tested with .009" (0.23mm) shim. All other models tested with .003" (0.08mm) shim.



Model 120022 2" (51mm) Super Air Amplifiers and Model 1122 2" Flat Super Air Nozzles blow off transmissions after they are machined.



(2) Model 120022 2" (51mm) Super Air Amplifiers dry small parts as they move down along a parts conveyor.



(5) Model 120022 2" (51mm) Super Air Amplifiers cool truck pistons.

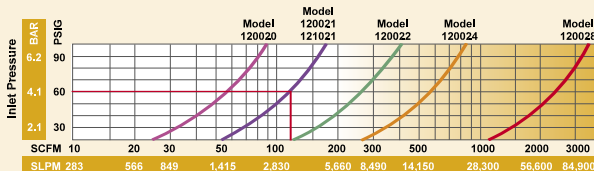

Total Output Flow with .003" (0.08mm) thick shim installed. Excludes downstream entrainment. Model 120028 tested with a .009" (0.23mm) shim.

How To Determine Super Air Amplifier Total Output Flow And Air Consumption

- Total Air flow:** From the performance curves (above), determine total output flow for any Super Air Amplifier at any pressure.
- Example:** A Model 120021 at 60 PSIG (4.1 BAR) supply air pressure has a total output flow of 120 SCFM (3,398 SLPM).
- Air Consumption:** Divide the total output flow by the amplification ratio (shown in the chart) to determine air consumption for any Super Air Amplifier at any pressure.

In the example above, the Model 120021 at 60 PSIG (4.1 BAR) supply air pressure has a total output flow of 120 SCFM (3,398 SLPM). Dividing this total output flow by its amplification ratio of 18 gives an air consumption of 6.7 SCFM (189 SLPM).

*Patent #5402938

Blowoff On A Transmission Pan

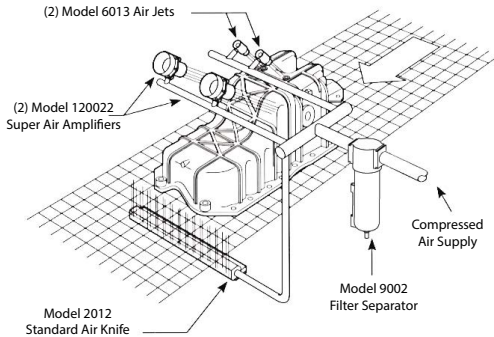

The Problem: A newly designed transmission pan presented a myriad of cleaning problems for the die-caster. Because the configuration included channels and blind holes as well as smooth surfaces, a “shaped” air pattern was required for proper cleaning. No single blowoff product would fit the need. An assortment of open copper tubes and drilled pipes was considered, but was rejected as too noisy and expensive

to operate. A blower was not an option due to the high purchase price, expensive maintenance costs and frequent downtime.

The Solution: With help from our Application Engineers, the company created a cleaning system incorporating a variety of EXAIR blowoff products. (2) **Model 6013 High Velocity Air Jets**, with their confined airstream, cleared the blind holes, while (2) **Model 120022 2" (51mm) Super Air Amplifiers** cleaned the channels. A **Model 2012 12" (305mm) Standard Air Knife** was positioned to blow out the casting’s underside.

Comment: There’s no doubt that the casting could have been cleaned just as well by hooking up a bunch of open copper tubes and throwing a ton of air at it. But, at what cost? EXAIR makes a variety of blowoff products because parts come in a variety of shapes and sizes. **And, our products operate at a fraction of the air consumption and noise levels associated with open air jets.** When you need to clean, cool, or dry with air, and you’d like to minimize dollars and decibels, EXAIR can help.

Super Air Amplifier Cools Iron Castings

The Problem: A foundry that produces iron castings for the automotive industry had a problem with certain hot parts that slowed their production. After pouring, the castings gradually cool by traveling along a 200 foot long conveyor. At the end, a shake-out conveyor breaks the sand mold so the casting can be removed. Normally, the operator could pick up the part with special gloves and grind the rough edges. However, some castings such as crankshafts, differential housings, and shift parts retained too much heat, making them too hot to handle. The operator had to wait up to ten minutes for them to cool.

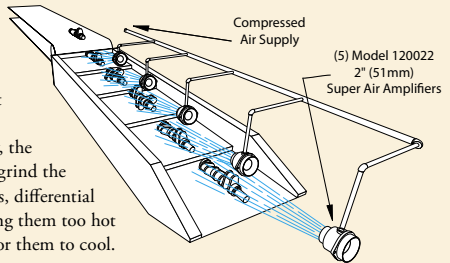

The Solution: They installed (5) **Model 120022 2" (51mm) Super Air Amplifiers** over the shake-out conveyor. The high output airflow from each Super Air Amplifier rapidly cooled the parts without shocking them (no cracks or imperfections from cooling too rapidly). **When the part reached the end of the conveyor, the operator could proceed immediately.** The backlog was completely eliminated.

Editor’s Comment: This manufacturer had almost given up on finding a cooling solution since the fans and blowers that were tried in the past showed little improvement. Our Super Air Amplifier dramatically reduced the cooling time. As a result, they installed them on their second line. The low cost Super Air Amplifiers are compact, portable and have no moving parts to wear out (which is ideal in a dusty foundry). **And, the patented design assures the highest output air volumes possible with the lowest air consumption.**

Super Air Amplifiers

Roaring Banana Breath

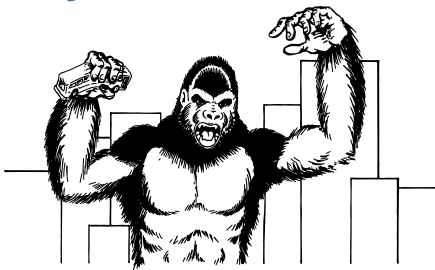

The Problem: A company that designs major attractions for theme parks created a huge gorilla to startle the patrons. The animators wanted the oversized ape to appear as “life-like” as possible. To accomplish this, they used a series of motors and cylinders to make the movement of the eyes, hands, arms and torso appear realistic. They also installed a large speaker system to play an audio sample of a loud roar that matched his mammoth size. The finishing touch was to find a way to create a powerful blast of air that smelled like bananas each time the big ape’s mouth opened. Attempts using an electrically powered blower

proved unsuccessful due to the noise and the inability to obtain an “instant on” blast of air.

The Solution: They installed a tank of banana extract in his tummy and connected it to his mouth with a **Model 120028 8" (203mm) Super Air Amplifier**. As the spectators moved into position, a sensor activated the electronics, setting “Old Banana Breath” (name given by the designers) into motion. With a swift movement toward the crowd, his mouth opens and the **Super Air Amplifier provides an instantaneous blast of high velocity air (filled with banana fumes) at them.**

Comment: Why did the engineers select the Super Air Amplifier? First, simplicity. There are no moving parts to wear out or require maintenance. It uses only filtered compressed air as the power source. Second is the big instantaneous blast of high volume, high velocity airflow that couldn’t be obtained using a blower or air nozzles. When it comes to special effects, Super Air Amplifiers are the way to go. When you watch the movies or visit the theme parks and see fast moving fog, smoke effects, or objects flying through the air, chances are a Super Air Amplifier is being used.

Cleaning Brake Rotors

The Problem: An automotive machine shop that manufactures brake rotors was having problems with chip build-up inside the part. They tried compressed air tubing flattened on their ends with little success. This resulted in high compressed air usage, high sound levels, and danger to their employees.

The Solution: A **Model 120021 1-1/4" (32mm) Super Air Amplifier** was substituted for the tubing. It provided a larger pattern of air, used less compressed air, the sound level was substantially lower, and it couldn’t be dead ended.

Comment: Bent tubing or drilled pipe are inexpensive and easy to make. However, the initial cost is overshadowed by its high energy use; holes can be blocked and noise level is excessive – both of which are OSHA violations. EXAIR’s Super Air Amplifiers are compact and dependable since there are no parts to wear out. Our patented design moves the most airflow possible while using the smallest amount of compressed air. The lower sound level was another bonus!

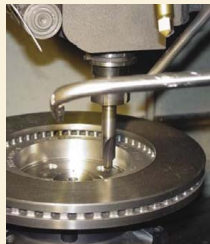

The Problem:

Model 120021 1-1/4" (32mm) Super Air Amplifier blows off parts and lowers sound levels.



The Solution:

Super Air Amplifier Dimensions

Super Air Amplifier Dimensions													
MODEL #		A	B	C	D	E	F	G	H	J	K	L	M
120020	in	0.45	0.75	0.98	1.77	2.28	0.20	0.18	0.53	0.73	2.50	0.59	1/8
	mm	11	19	25	45	58	5	5	13	19	64	15	NPT
120021	in	0.84	0.94	1.50	2.40	3.03	0.27	0.21	0.75	1.22	2.88	0.59	1/4
	mm	21	24	38	61	77	7	5	19	31	73	15	NPT
120022	in	1.64	1.69	2.95	3.58	4.14	0.27	0.25	0.75	2	3	0.62	3/8
	mm	42	43	75	91	105	7	6	19	51	76	16	NPT
120024	in	3.02	2.81	4.91	6.89	8.42	0.55	0.55	1.75	3.97	4.75	0.94	1/2
	mm	77	71	125	175	214	14	14	44	101	121	24	NPT
120028	in	6.20	4.50	9	---	11.25	---	---	2.44	8	8.94	2.38	3/4
	mm	157	114	229	---	286	---	---	62	203	227	60	NPT

DOWNLOAD drawings at EXAIR.com

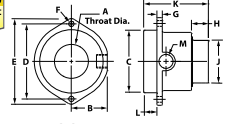

Model 120020-120024

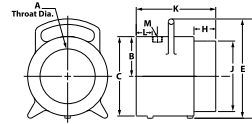

Model 120028

Air Amplifiers

Airflow Pattern

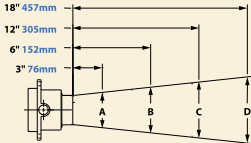

MODEL #	A	B	C	D	
120020	in	1.25	2.2	4.1	6
	mm	32	56	104	152
120021	in	2	2.9	4.7	6.5
	mm	51	74	119	165
120022	in	2.75	3.55	5.15	6.75
	mm	70	90	131	171
120024	in	4.5	5.3	6.9	8.5
	mm	114	135	175	216

Airflow Pattern

Model 120028

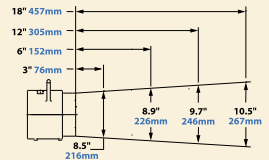

Super Air Amplifier Models

Super Air Amplifier Only

Super Air Amplifier Kits - include a Super Air Amplifier, shim set, filter separator and pressure regulator (with coupler).

Deluxe Super Air Amplifier Kits - include a Super Air Amplifier, EFC, shim set, filter separator and pressure regulator (with coupler).

Super Air Amplifier Shim Sets - include (1) .006" (0.15mm) and (1) .009" (0.23mm) stainless steel shims (except 8" which include (1) .015" (0.39mm) stainless steel shim).

Outlet Diameter	Super Air Amplifier Only Model	Super Air Amplifier Kit Model	Deluxe Super Air Amplifier Kit Model	High Temperature Air Amplifier Only Model	High Temperature Air Amplifier Kit Model	Super Air Amplifier Shim Set Model
3/4" (19mm)	120020	120220	120220DX	N/A	N/A	120320
1-1/4" (32mm)	120021	120221	120221DX	121021	121221	120321
	120022	120222	120222DX	N/A	N/A	120322
4" (102mm)	120024	120224	120224DX	N/A	N/A	120324
8" (203mm)	120028	120228	120228DX	N/A	N/A	120328



Kits include a Super Air Amplifier, shim set, filter separator and pressure regulator (with coupler).



Order EXAIR's EFC™ electronic flow control to minimize compressed air use. See page 7 for details.



Accessories

Model #	Description
9001	Auto Drain Filter Separator, 3/8 NPT, 65 SCFM (1,841 SLPM)
9032	Auto Drain Filter Separator, 1/2 NPT, 90 SCFM (2,549 SLPM)
9002	Auto Drain Filter Separator, 3/4 NPT, 220 SCFM (6,230 SLPM)
9005	Oil Removal Filter, 3/8 NPT, 15-37 SCFM (425-1,048 SLPM)
9006	Oil Removal Filter, 3/4 NPT, 50-150 SCFM (1,416-4,248 SLPM)
9008	Pressure Regulator with Gauge, 1/4 NPT, 50 SCFM (1,416 SLPM)
9033	Pressure Regulator with Gauge, 1/2 NPT, 100 SCFM (2,832 SLPM)
9009	Pressure Regulator with Gauge, 3/4 NPT, 220 SCFM (6,230 SLPM)

Order Direct
We Ship From Stock

ORDER ONLINE
at EXAIR.com

Adjustable Air Amplifier™

Highly effective air mover that easily adjusts to your application!

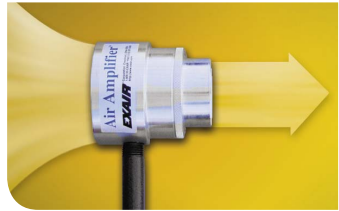

What Is The Adjustable Air Amplifier?

The air gap is infinitely adjustable which regulates the consumption and outlet flow from a “breeze” to a “blast”. They are available in aluminum or in stainless steel for food service, higher temperatures (400°F/204°C), and corrosive applications. High Temperature Stainless Steel Air Amplifiers for temperatures up to 700°F (374°C) are also available. Please contact an Application Engineer.

Force and flow for the Adjustable Air Amplifier is changed by turning the exhaust end (with the knurled ring loose) to open or close the continuous air gap. When desired performance is obtained, the knurled ring can be tightened to lock the flow at that setting. In most cases, a .002” to .004” (0.05mm to 0.10mm) air gap is ideal.

Adjustable Air Amplifier Performance at 80 PSIG (5.5 BAR)

MODEL	Air Consumption		Amplification RATIO	Air Volume at Outlet		Air Volume at 6" (152mm)		Sound Level dBA
	SCFM	SLPM		SCFM	SLPM	SCFM	SLPM	
6030, 6040	8.9	252	10	89	2,520	267	7,560	78
6031, 6041	12.9	365	16	206	5,833	618	17,500	81
6032, 6042	21.5	608	20	430	12,176	1,290	36,529	82
6033, 6043	35.2	997	22	774	21,917	2,323	65,780	83
6034, 6044	50	1,416	24	1,200	33,980	3,600	101,941	84

Tested with .002” (0.05mm) gap.

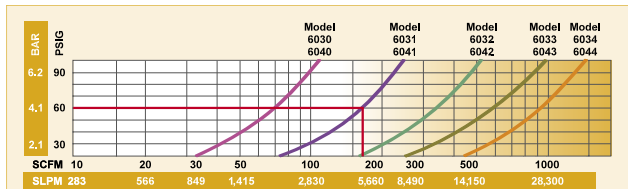

Total Output Flow with .002” (0.05mm) gap setting. Excludes downstream entrainment.

How To Determine Adjustable Air Amplifier Total Output Flow And Air Consumption

Total Airflow: From the performance curves (above), determine total output flow for any Adjustable Air Amplifier at any pressure.

Example: A Model 6031 at 60 PSIG (4.1 BAR) supply air pressure has a total output flow of 165 SCFM (4,672 SLPM).

Air Consumption: Divide total output flow by the amplification ratio (shown in the chart) to determine air consumption for any Adjustable Air Amplifier at any air pressure.

In the example above, the Model 6031 at 60 PSIG (4.1 BAR) supply air pressure has a total output flow of 165 SCFM (4,672 SLPM). Dividing this total flow by its amplification ratio of 16 gives an air consumption of 10.3 SCFM (292 SLPM).



Model 6042 2" (51mm) Adjustable Air Amplifiers with swivel fittings cool inductively heated axles prior to installing the hubs.



Metal parts are dried using a series of Model 6042 2" (51mm) Adjustable Air Amplifiers.

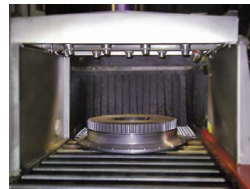

A series of Adjustable Air Amplifiers dry and cool a large machined casting as it exits a high temperature wash.

Adjustable Air Amplifiers

Adjustable Air Amplifier Dimensions

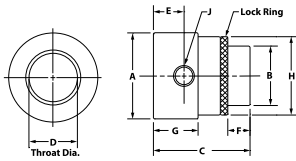

DOWNLOAD
Drawings at
EXAIR.com

Built to Last
5 Yr.
WARRANTY



Adjustable Air Amplifiers and High Velocity Air Jets dry an engine block prior to assembly.

Adjustable Air Amplifier Dimensions										
MODEL #	A	B	C	D	E	F	G	H	J	
6030	in	1.50	0.75	2.22	0.45	0.72	0.56	1.06	1.25	1/8
6040	mm	38	19	57	11	18	14	27	32	NPT
6031	in	2	1.25	2.88	0.84	1	0.75	1.38	1.75	1/4
6041	mm	51	32	73	21	25	19	35	44	NPT
6032	in	3.13	2	3.25	1.64	1.06	0.75	1.50	2.75	3/8
6042	mm	79	51	83	42	27	19	38	70	NPT
6033	in	4	3	4.06	2.20	1.22	1.25	1.83	3.50	1/2
6043	mm	102	76	103	56	31	32	46	89	NPT
6034	in	5	4	5	3.02	1.50	1.75	2.13	4.50	1/2
6044	mm	127	102	127	77	38	44	54	114	NPT

Need Swivels?
EXAIR's Swivel Fittings make it easy to adjust the aim of Air Amplifiers.
See page 66 for details.

Adjustable Air Amplifier Systems

Adjustable Air Amplifier Models

Adjustable Air Amplifier Only

Adjustable Air Amplifier Kits - include an Adjustable Air Amplifier, filter separator and pressure regulator (with coupler).

Deluxe Adjustable Air Amplifier Kits - include an Adjustable Air Amplifier, EFC, filter separator and pressure regulator (with coupler).

Outlet Diameter	Aluminum Adjustable Air Amplifier Only Model	Aluminum Adjustable Air Amplifier Kit Model	Deluxe Aluminum Adjustable Air Amplifier Kit Model	Stainless Steel Adjustable Air Amplifier Only Model	Stainless Steel Adjustable Air Amplifier Kit Model	Deluxe Stainless Steel Adjustable Air Amplifier Kit Model
3/4" (19mm)	6040	6240	6240DX	6030	6230	6230DX
1-1/4" (32mm)	6041	6241	6241DX	6031	6231	6231DX
2" (51mm)	6042	6242	6242DX	6032	6232	6232DX
3" (76mm)	6043	6243	6243DX	6033	6233	6233DX
4" (102mm)	6044	6244	6244DX	6034	6234	6234DX

Accessories

Model #	Description
9001	Auto Drain Filter Separator, 3/8 NPT, 65 SCFM (1,841 SLPM)
9032	Auto Drain Filter Separator, 1/2 NPT, 90 SCFM (2,549 SLPM)
9002	Auto Drain Filter Separator, 3/4 NPT, 220 SCFM (6,230 SLPM)
9005	Oil Removal Filter, 3/8 NPT, 15-37 SCFM (425-1,048 SLPM)
9006	Oil Removal Filter, 3/4 NPT, 50-150 SCFM (1,416-4,248 SLPM)
9008	Pressure Regulator with Gauge, 1/4 NPT, 50 SCFM (1,416 SLPM)
9033	Pressure Regulator with Gauge, 1/2 NPT, 100 SCFM (2,832 SLPM)
9009	Pressure Regulator with Gauge, 3/4 NPT, 220 SCFM (6,230 SLPM)

Airflow Pattern

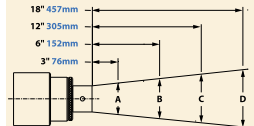

MODEL #	A	B	C	D	
6030	in	1.5	2.4	4.2	6
6040	mm	38	61	107	152
6031	in	2	2.9	4.7	6.5
6041	mm	51	74	119	165
6032	in	2.5	3.4	5.2	7
6042	mm	64	86	132	178
6033	in	3.5	4.6	6.5	8
6043	mm	89	117	165	203
6034	in	5	5.8	7.4	9
6044	mm	127	147	188	229



Kits include an Adjustable Air Amplifier, filter separator and pressure regulator (with coupler).