

usipipe™

MODULAR ALUMINUM PIPING SYSTEM



AIR

NITRO

VAC

HP

PRODUCT MANUAL

Fast Installation

No Special Tools Needed

Pressures up to 1015 PSI

13 Pipe Sizes Available

Exceptionally Secure Joints

The Unipipe Advantage	3 - 5	Install Special Flange	29
Flow Rate Table	6	Install Reducer	29
AIR Unipipe AIR 232 PSI	7 - 11	Install Reducer in Fitting	30
NITRO Unipipe NITRO 232 PSI	16 - 19	Install Plug in Fitting	30
VAC Unipipe VAC -29 inHg	20 - 24	Install Branch Pipe x Pipe 1" to 2-1/2" (25mm-63mm)	31
HP Unipipe HP 1015 PSI	25 - 28	Install Saddle Branch Pipe x FNPT 1" to 10" (25mm-250mm)	32
Accessories	12 - 15	Unipipe Assembly Instructions 3/4" to 3-1/2" (20mm-90mm)	33
Saddle Branches	Wall Mounted Manifolds	Unipipe Assembly Instructions 4-1/2" to 10" (110mm-250mm)	34
Pipe x FNPT	Pipe Clips		
Branches	Pipe Cutters		
Pipe x Pipe	Miscellaneous Tools		
Fitting Plugs			
Offset Nipples			

Certificates & Declarations

ISO 9001:2008

SGS Certificate ES13/13865

CNR Number for All Canadian Provinces

- Category A - OA16981.5
- Category B - OB21369.5
- Category C - OC21414.5
- Category D - OD21371.5
- Category H - OH21366.5

Pipe Coating Quality Certificate

Pressure / Temperature Certification

6°F/3488 PSI (-15°C/240.5 Bar)
248°F / 2886 PSI (+140°C/199 Bar)

Unipipe Product Warranty - 20 Years

Conformity Declaration according to PED

ASME B31.3 - B31.9 2014/68/UE

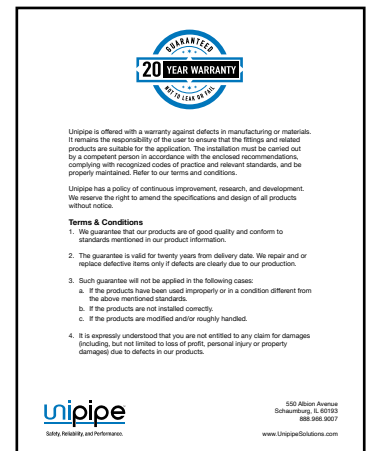
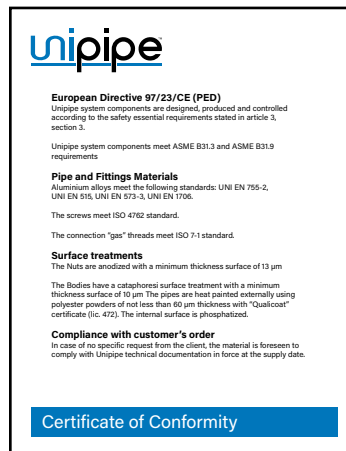
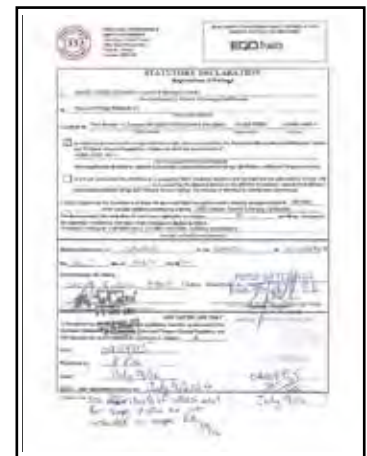

Four Options - Many Applications

No Special Tools Required

Unipipe is a modular aluminum piping system available in a broad range of sizes, pressures, and fittings. The heavy-wall pipe is rated for 1000 PSI and no special tools are required for assembly or installation. All piping and fittings are 100% aluminum. It is available in the broadest range of sizes on the market - 3/4" to 10" diameters.

Pressure Capacity

The Unipipe System is suitable for a very wide pressure ranges from high vacuum to 1000 PSI.

Vast Temperature Capabilities

Unipipe offers a range of working temperature from -4°F up to 212°F (-20°C up to 100°C).

Quick & Easy

Unipipe connects together quickly and easily. Only basic, standard tools are required to create complex piping systems. No grooving or crimping are necessary.

Flexible

Unipipe's range of pipe sizes and fittings offer one of the most convenient, flexible and dynamic piping solutions on the market. It is suitable for many different applications.

Universal

Unipipe offers the widest product range for the transport of compressed air, inert gases, and vacuum, as well as high pressure air and fluids.

13 Pipe Sizes Available

20mm	3/4"
25mm	1"
32mm	1-1/4"
40mm	1-1/2"
50mm	2"
63mm	2-1/2"
75mm	3"
90mm	3-1/2"
110mm	4-1/2"
140mm	5"
160mm	6"
200mm	8"
250mm	10"

SPECIFICATIONS	UnipipeAIR	UnipipeNITRO	UnipipeVAC	UnipipeHP
Max Working Pressure	232 PSI (16 BAR)	232 PSI (16 BAR)	25.7 (4-1/2" to 10") -29 inHg (3/4" to 3-1/2")	435-580-1015 PSI (30-40-70 BAR)
Plant Testing Pressure 1 hour at 20°C	348 PSI (24 BAR)	348 PSI (24 BAR)	348 PSI (24 BAR)	652-870-1522 PSI (45-60-105 BAR)
Quality Testing Pressure 1 hour at 20°C	928 PSI (64 BAR)	928 PSI (64 BAR)	928 PSI (64 BAR)	1740-2320-4061 PSI (120-160-280 BAR)
Continuous Working Temperature	From -4°F to 212°F (-20°C up to 100°C)			
Max Working Temperature	From -22°F Up to 266°F (-30°C Up to 130°C)			
Thread Standard	NPT National Pipe Thread complying to ANSI B1.20.1			
Aluminium Pipe Mechanical Resistance	According to EN-755-2/2008 standards			
Pipe Material	Aluminium Alloy EN AW 6060 - T5 according to EN 755-2/2008			
Aluminium Fittings Material	Aluminium Alloy EN Aw 6061 T6			
O-Ring & Lip Gasket Material	HNBR 65°/75° Shore A			
Clamp Ring Material	AISI 304 Stainless Steel			

The Unipipe Advantage

The Unipipe design produces a fitting with exceptionally secure joints that is superior to every other aluminium pipe system. The brilliant engineered design with quality material selection produces a system in which the actual pipes will burst before the fitting fails in a destructive test.



Test at 7700 PSI (535 bar)
Pipe bursts but no failure of the fittings.

Independent Laboratory Test Report Destructive Pressure Test to Burst Point

Seal Type	Temp	Bar	PSI
FPM	5°F / -15°C	240.5	3488
HNBR	-22°F / -30°C	243.2	3527
FPM	284°F / +140°C	199	2886
HNBR	212°F / +100°C	202.9	2943



Photo of test at -22°F (-30°C) with NBR seals
Pipe bursts at 3527 PSI (243.2 bar) pressure but no failure of the fittings.



Photo of test at 212°F (+100°C) with NBR seals
Pipe bursts at 2942 PSI (202.9 bar) pressure but no failure of the fittings.



Gripping Action for Rapid Installation

A system of aluminum piping and fittings that offers fast installation and exceptionally secure joints.

The internal nut and dynamic gripping ring ensure there is no way to separate the pipe from the fittings. This innovative fitting is small and light, making this system one of the most powerful methods for transporting air, gases, and liquids. The plastic ring conveniently identifies the fluid and working pressure for each system.

Sizes 3/4" to 3-1/2" (20mm—90mm)

1. Aluminum Nut
2. Colored Identification Ring
3. Stainless Steel Clamp Ring
4. HNBR O-Ring
5. Machined Aluminium Body



**The highest pressure rated
aluminum pipe system
on the market.**

**The pipe will burst
before the fitting will fail!**

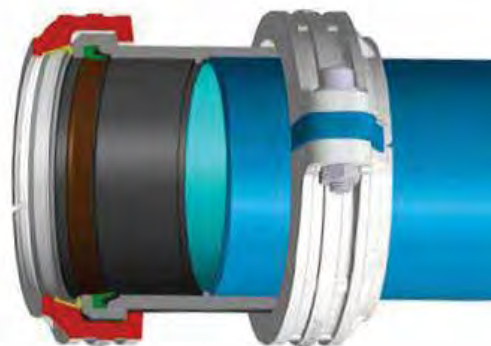

Sizes 4-1/2" to 10" 110mm—250mm

1. Stainless Steel Clamp Ring
2. Half Clamp Body Ring
3. HNBR O-Ring
4. Colored Identification Mark
5. Machined Aluminum Body
6. Bolts



Flow Rate Distance from compressor to furthest outlet / 100 PSI with 4% allowed pressure loss

NI/min	Nm3/h	cfm	80'	160'	320'	500'	650'	1000'	1300'	1600'	3300'	4900'	6500'
230	14	8	20	20	20	20	20	20	20	20	25	25	25
650	39	23	20	20	20	25	25	25	32	32	32	40	40
900	54	32	20	20	25	25	32	32	32	32	40	40	40
1200	72	42	25	25	25	32	32	32	32	40	40	50	50
1750	105	62	25	25	32	32	32	40	40	40	50	50	63
2000	120	71	32	32	32	32	40	40	40	40	50	63	63
2500	150	88	32	32	32	40	40	40	50	50	63	63	63
3000	180	106	32	32	40	40	40	50	50	50	63	63	63
3500	210	123	40	40	40	40	50	50	50	50	63	63	75
4500	270	159	40	40	40	50	50	50	63	63	63	75	75
6000	360	212	50	50	50	50	50	63	63	63	75	75	90
7000	420	247	50	50	50	50	63	63	63	75	75	90	90
8500	510	300	63	63	63	63	63	63	75	75	90	90	90
12000	720	424	63	63	63	63	75	75	75	90	90	110	110
15000	900	530	75	75	75	75	75	90	90	90	110	110	140
18000	1080	635	75	75	75	75	75	90	90	90	110	140	140
21000	1260	741	90	90	90	90	90	90	90	110	110	140	140
26000	1559	918	90	90	90	90	90	110	110	110	140	140	140
31000	1859	1095	110	110	110	110	110	110	110	110	140	140	160
33000	1979	1165	110	110	110	110	110	110	110	140	140	140	160
44000	2639	1554	140	140	140	140	140	140	140	140	160	160	200
50000	2999	1766	140	140	140	140	140	140	140	140	160	200	200
58000	3479	2048	140	140	140	140	140	140	140	160	160	200	200
67000	4019	2366	160	160	160	160	160	160	160	160	200	200	200
75000	4499	2648	160	160	160	160	160	160	160	160	200	200	200
83000	4979	2931	160	160	160	160	160	160	160	160	200	200	250
92000	5519	3249	200	200	200	200	200	200	200	200	200	250	250
100000	5999	3531	200	200	200	200	200	200	200	200	200	250	250
125000	7500	4414	200	200	200	200	200	200	200	200	250	250	250
150000	9000	5297	250	250	250	250	250	250	250	250	250	250	
200000	12000	7062	250	250	250	250	250	250	250	250	250		
208333	12500	7357	250	250	250	250	250	250	250	250			
250000	15000	8828	250	250	250	250	250	250	250	250			

The pipe length shown in the table refers to an installation with a single mainline. In the case of a ring main installation, with pipes of the same diameter and length, the pressure losses will be reduced by 50% and will increase the stability of the whole system.

- Velocity less than 20 feet per second
- Velocity from 20 - 33 feet per second
- Velocity from 33 - 50 feet per second (not recommended)

UnipipeAIR Pipe 232 PSI (16 bar)

Part No.	Size Ømm	Size Inches	Wall Thickness mm	Length m	Length Feet	Weight
UATT0.020600	20	3/4"	1.0	6	19.6	2.1 lbs.
UATT0.025600	25	1"	1.1	6	19.6	2.9 lbs.
UATT0.032600	32	1-1/4"	1.2	6	19.6	4.1 lbs.
UATT0.040600	40	1-1/2"	1.3	6	19.6	5.7 lbs.
UATT0.050600	50	2"	1.4	6	19.6	7.7 lbs.
UATT0.063600	63	2-1/2"	1.8	6	19.6	12.4 lbs.
UATT0.075600	75	3"	2	6	19.6	17.9 lbs.
UATT0.090600	90	3-1/2"	2.4	6	19.6	23.8 lbs.
UATT0.110600	110	4-1/2"	3.0	6	19.6	35.7 lbs.
UATT0.140600	140	5"	2.8	6	19.6	44.7 lbs.
UATT0.160600	160	6"	4.3	6	19.6	75.4 lbs.
UATT0.200600	200	8"	4	6	19.6	89.3 lbs.
UATT0.250600	250	10"	5	6	19.6	141 lbs.



Straight Coupling 232 PSI (16 bar)

Part No.	Size Ømm	A	L	E	S	Weight
UACC0.020020	20	70	35	37	29	2.5 oz
UACC0.025025	25	75	37	42	36	3.4 oz
UACC0.032032	32	94	46	51	43	6.1 oz
UACC0.040040	40	117	57	63	53	11.9 oz
UACC0.050050	50	138	68	78.5	66	1.2 lbs
UACC0.063063	63	173	83	95	82	2.2 lbs
UACC0.075075	75	174	85.4	108	100	2.4 lbs
UACC0.090090	90	190	93	132	118	3.9 lbs
UACC0.110110	110	150	73	206	154	4.8 lbs
UACC0.140140	140	Coming	Soon			
UACC0.160160	160	Coming	Soon			
UACC0.200200	200	Coming	Soon			
UACC0.250250	250	Coming	Soon			

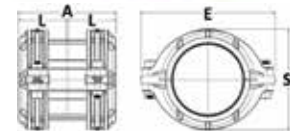
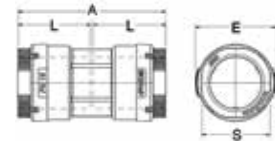

Sliding Straight Coupling 232 PSI (16 bar)

Part No.	Size Ømm	A	E	S	Weight
UACC1.020020	20	70	37	29	2.5 oz
UACC1.025025	25	75	42	36	3.4 oz
UACC1.032032	32	94	51	33	6.1 oz
UACC1.040040	40	117	63	53	11.9 oz
UACC1.050050	50	138	78.5	66	1.2 lbs
UACC1.063063	63	173	95	82	2.2 lbs
UACC1.075075	75	174	108	100	2.4 lbs
UACC1.090090	90	190	132	118	3.9 lbs

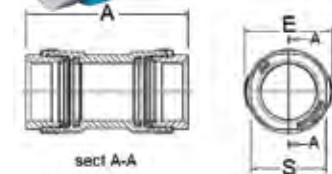

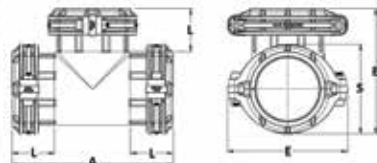
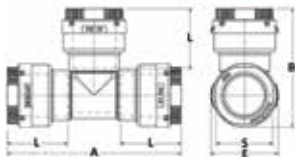
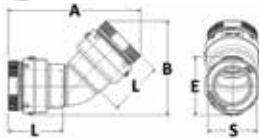
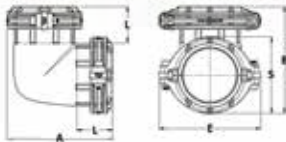
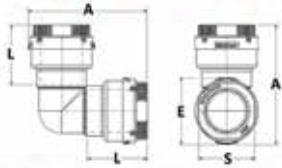

90° Elbow 232 PSI (16 bar)

Part No.	Size Ømm	A	E	L	S	Weight
UACC9.020020	20	60	37	35	29	3 oz
UACC9.025025	25	76	42	37	36	4 oz
UACC9.032032	32	90	51	46	43	7.2 oz
UACC9.040040	40	112	63	57	53	1.2 oz
UACC9.050050	50	143	79	68	66	1.5 oz
UACC9.063063	63	168	95	83	82	2.4 lbs
UACC9.075075	75	190	108	85	100	2.8 lbs
UACC9.090090	90	219	132	93	118	5.5 lbs
UACC9.110110	110	214	206	73	154	7.6 lbs
UACC9.140140	140	Coming	Soon			
UACC9.160160	160	352	266	133.5	221	25.2 lbs
UACC9.200200	200	Coming	Soon			
UACC9.250250	250	Coming	Soon			

45° Elbow 232 PSI (16 bar)

Part No.	Size Ømm	A	B	E	L	S	Weight
UACC4.020020	20	85	59	37	35	29	3.2 oz
UACC4.025025	25	95	68	42	37	36	3.9 oz
UACC4.032032	32	119	84	51	46	43	7.2 oz
UACC4.040040	40	141	101	63	57	53	12 oz
UACC4.050050	50	171	124	78.5	68	66	1.4 lbs
UACC4.063063	63	207	150	95	83	82	2.3 lbs

Equal Tee 232 PSI (16 bar)

Part No.	Size Ømm	A	B	E	L	S	Weight
UACCT.020020	20	101	68	37	35	29	4.3 oz
UACCT.025025	25	111	75	42	37	36	5.7 oz
UACCT.032032	32	136	93	51	46	43	10.3 oz
UACCT.040040	40	162	110	63	57	53	1 lb
UACCT.050050	50	206	141	78.5	68	66	2 lbs
UACCT.063063	63	230	160	95	83	82	3.1 lbs
UACCT.075075	75	260	219.9	108	85	100	4 lbs
UACCT.090090	90	306	217	132	93	118	7.5 lbs
UACCT.110110	110	277	214	206	73	154	10 lbs
UACCT.140140	140	Coming	Soon				
UACCT.160160	160	484	352	265	133.5	221	36.7 lbs
UACCT.200200	200	Coming	Soon				
UACCT.250250	250	Coming	Soon				

Tee with FNPT Branch Line 232 PSI (16 bar)

Part No.	Size Ømm	A	B	E	L	S	Weight
UACFT.020015N	20 x 1/2" x 20	101	48	37	35	29	3.4 oz
UACFT.025020N	25 x 3/4" x 25	111	57	42	37	36	4.7 oz
UACFT.032025N	32 x 1" x 32	136	70	51	46	43	7.8 oz
UACFT.040032N	40 x 1 1/4" x 40	162	78	63	57	53	12.8 oz
UACFT.050040N	50 x 1 1/2" x 50	206	95	78.5	66	66	1.6 lbs
UACFT.063050N	63 x 2" x 63	230	114	95	83	82	2.5 lbs



90° with MNPT 232 PSI (16 bar)

Part No.	Size Ømm	A	B	E	L	S	Weight
UACM9.020015N	20 x 1/2"	62	48	37	35	29	1.8 oz
UACM9.025015N	25 x 1/2"	67	56	42	37	36	2.5 oz
UACM9.025020N	25 x 3/4"	67	57	42	37	36	2.6 oz
UACM9.032025N	32 x 1"	87	70	51	46	43	4.9 oz
UACM9.040032N	40 x 1 1/4"	105	80	63	57	53	9 oz
UACM9.040040N	40 x 1 1/2"	105	78	63	57	53	10 oz
UACM9.040050N	40 x 2"	111	85	63	57	53	11 oz
UACM9.050040N	50 x 1 1/2"	126	95	78.5	66	66	14.8 oz
UACM9.063050N	63 x 2"	159	114	95	83	82	1.8 lbs



MNPT Adapter 232 PSI (16 bar)

Part No.	Size Ømm	A	E	S	L	Weight
UACM0.020015N	20 x 1/2"	49	37	29	35	1.4 oz
UACM0.020020N	20 x 3/4"	51.5	37	29	35	1.4 oz
UACM0.025015N	25 x 1/2"	55	42	36	37	2 oz
UACM0.025020N	25 x 3/4"	55	42	36	37	2 oz
UACM0.025025N	25 x 1"	60.5	42	36	37	2 oz
UACM0.032025N	32 x 1"	68	51	43	46	3.9 oz
UACM0.032032N	32 x 1 1/4"	70	51	43	46	3.9 oz
UACM0.040032N	40 x 1 1/4"	81	63	53	57	6.5 oz
UACM0.040040N	40 x 1 1/2"	81	63	53	57	6.5 oz
UACM0.050040	50 x 1 1/2"	92	78.5	66	68	11.2 oz
UACM0.050050N	50 x 2"	95.5	78.5	66	68	11.2 oz
UACM0.063050N	63 x 2"	119	95	82	83	1.2 lbs
UACM0.063063N	63 x 2 1/2"	121	95	82	83	1.2 lbs
UACM0.075075N	75 x 2 1/2"	122.9	108	100	85.4	1.4 lbs
UACM0.090075N	90 x 3"	130	132	118	93	2.2 lbs



FNPT Adapter 232 PSI (16 bar)

Part No.	Size Ømm	A	E	L	S	Weight
UACF0.020015N	20 x 1/2"	55	37	35	29	2 oz
UACF0.025020N	25 x 3/4"	57	42	37	36	2.3 oz
UACF0.032025N	32 x 1"	69	51	46	43	4.1 oz
UACF0.040032N	40 x 1 1/4"	80	63	57	53	8.1 oz
UACF0.050040N	50 x 1 1/2"	95	78	66	66	11.6 oz
UACF0.063050N	63 x 2"	120	95	83	82	1.4 lbs





Flange Adapter 232 PSI (16 bar)

Part No.	Size Ømm	A	B	E	F	G	M	L	S	Weight
UACJF.090075	90 x 3"	Coming	Soon							
UACJF.110100	110 x 4"	99	73	206	18	220	180	75	154	5.5 lbs
UACJF.140125	140 x 5"	Coming	Soon							
UACJF.160150	160 x 6"	184	171	221	23.5	283	240.5	133.5	221	16.4 lbs
UACJF.200200	200 x 8"	Coming	Soon							
UACJF.250250	250 x 10"	Coming	Soon							

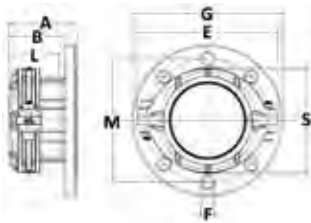

Special Flange (fitting x flange adapter) Elbow or Tee 232 PSI (16 bar)

Part No.	Pipe Size	Flange Description	A	B	F	M	S
UAZJF.110100	100	DN100 - 4"	220	*	18	180	*
UAZJF.110101	140	DN125 - 5"	Coming	Soon			
UAZJF.160150	160	DN150 - 6"	283	39	23.5	240.5	186
UAZJF.160151	200	DN200 - 8"	Coming	Soon			
UAZJF.160152	250	DN250 - 10"	Coming	Soon			

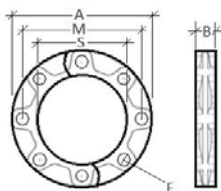

Reducer (fitting x pipe) 232 PSI (16 bar)

Part No.	Size Fitting D1 Ømm	Size Outlet D2 Ømm	A	E	L	S	Weight
UASC0.025020	25	20	46	33	35	29	1.8 oz
UASC0.032020	32	20	Coming	Soon			
UASC0.032025	32	25	52.6	42	37	36	2.9 oz
UASC0.040020	40	20	59.5	52	35	29	5.4 oz
UASC0.040025	40	25	60.6	52	37	36	6.1 oz
UASC0.040032	40	32	54.6	52	46	43	4.2 oz
UASC0.050032	50	32	Coming	Soon			
UASC0.050040	50	40	73	64.8	57	53	8.5 oz
UASC0.063040	63	40	86.3	79.5	57	53	13.9 oz
UASC0.063050	63	50	84	79.5	68	66	14.7 oz
UASC0.075075	75	63	93	108	85	100	1.3 lbs
UASC0.090063	90	63	111.8	114	83	82	2.5 lbs
UASC0.110090	110	90	117	123	93	118	2.8 lbs
UASC0.140110	110	110	Coming	Soon			
UASC0.160110	160	110	175	200	73	154	5.7 lbs
UASC0.200160	200	160	Coming	Soon			
UASC0.250200	250	200	Coming	Soon			

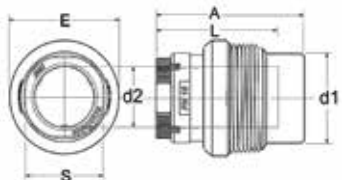

Ball Valve (pipe x pipe) 232 PSI (16 bar)

Part No.	Pipe - Pipe Ømm	A	B	E	G	L	L	Weight
UACCV.020020	20	131	73	40	99	35	35	8.1 oz
UACCV.025020	25 x 20	131	73	40	102	37	37	8.4 oz
UACCV.025025	25	150	87	50	110.5	37	37	13.4 oz
UACCV.032032	32	203	111	61	137	46	46	1.5 lbs
UACCV.040040	40	213	121	72	169	57	57	2.1 lbs
UACCV.050050	50	282	156	89	200	68	68	3.5 lbs
UACCV.063063	63	306	176	109	253.5	83	83	6 lbs



Ball Valve - (pipe x MNPT) 232 PSI (16 bar)

Part No.	Pipe Ømm - Thread	A	B	E	G	L	S	Weight
UACMV.020015N	20 x 1/2"	131	73	40	94	35	29	7.4 oz
UACMV.025020N	25 x 3/4"	150	87	50	104.5	37	36	12.2 oz
UACMV.032025N	32 x 1"	203	111	61	132	46	43	1.3 lbs
UACMV.040032N	40 x 1 1/4"	213	121	72	145.5	57	53	1.9 lbs
UACMV.050040N	50 x 1 1/2"	282	156	89	187.5	68	66	3.2 lbs
UACMV.063050N	63 x 2"	306	176	109	217	83	82	5.5 lbs



Three Way Ball Valve 232 PSI (16 bar)

Part No.	Pipe Ømm	A	B	E	G	L	S
UACCVT.032032	32	Coming	Soon				
UACCVT.040040	40	Coming	Soon				
UACCVT.050050	50	Coming	Soon				



Wall Mounted Drop End 232 PSI (16 bar)

Part No.	Inlet Ømm spigot	Outlet G	No of outlets	A	B	F	G	M	Weight
UASFS.025015	25	1/2"	1	99	72	6	24	83	5.1 oz
UASFD.025015	25	1/2"	2	99	72	6	24	83	5.7 oz



The Versatile Unipipe Wall Mounted Drop End

The versatile wall outlet (single or double) can be direct coupled with any of these fixtures;

- Coupling
- Tee (horizontal or vertical)
- Elbow
- Valve

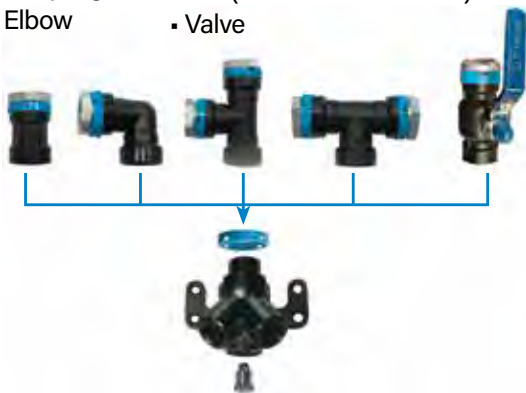

1. I.D. Ring
2. Outlet
3. Purge Valve



Accessories

For use with
 UnipipeAIR
 UnipipeNITRO
 UnipipeVAC
 UnipipeHP

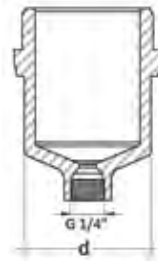

Fitting Plug with Purge Valve

Part No.	Plug Ømm	Pressure bar	Pressure PSI	Weight
UASV0.020008	20	70	1015	1.1 oz
UASV0.025008	25	70	1015	1.4 oz
UASV0.032008	32	70	1015	2 oz
UASV0.040008	40	70	1015	3.2 oz
UASV0.050008	50	70	1015	5.8 oz
UASV0.063008	63	70	1015	10 oz
UASV0.090008	90	16	232	12.1 oz
UASV0.110008	110	16	232	14.5 oz
UASV0.160008	160	16	232	2.7 lbs

Saddle Branch (pipe x FNPT) 580 PSI (40 bar) /232 PSI (16 bar)



Part No.	Size Ømm	psi	A	A1	A2	B	B1	B2	C	Weight
UCHF0.025015N	25 x 1/2"	580	62	25	37	51	17.5	17.5	33	2.5 oz.
UCHF0.032015N	32 x 1/2"	580	75	32	42.5	57.5	21.5	21.5	33	3.2 oz
UCHF0.040015N	40 x 1/2"	580	89.5	41	48.5	69.5	27	27	47	5.7 oz
UCHF0.040020N	40 x 3/4"	580	89.5	41	48.5	69.5	27	27	47	5.4 oz
UCHF0.050015N	50 x 1/2"	580	102	46.5	55.5	84	32	32	47	7.7 oz
UCHF0.050020N	50 x 3/4"	580	102	46.5	55.5	84	32	32	47	7.2 oz
UCHF0.050025N	50 x 1"	580	102	46.5	55.5	84	32	32	47	6.6 oz
UCHF0.063015N	63 x 1/2"	580	122	58	64	99	40	40	58	12.9 oz
UCHF0.063020N	63 x 3/4"	580	122	58	64	99	40	40	58	12.6 oz
UCHF0.063025N	63 x 1"	580	122	58	64	99	40	40	58	11.8 oz
UCHF0.075025N	75 x 1"	232	121.6	67.8	53.8	110.5	44.8	65.7	60	9.9 oz
UCHF0.075050N	75 x 2"	232	121.6	67.8	53.8	122.1	44.8	77.3	80	14.1 oz
UCHF0.090025N	90 x 1"	232	159.5	71.5	88	130	53	53	66	1.1 lbs
UCHF0.090050N	90 x 2"	232	159.5	71.5	88	130	53	53	66	1.3 lbs
UCHF0.110025N	110 x 1"	232	179.5	81	98	150	65	65	66	1.3 lbs
UCHF0.110050N	110 x 2"	232	179.5	81	98	150	65	65	80	2.5 lbs
UCHF0.110075N	110 x 3"	232	179.5	81	98	150	65	65	122	3.4 lbs
UCHF0.140050N	140 x 2"	Coming	Soon							
UCHF0.140075N	140 x 3"	Coming	Soon							
UCHF0.160050N	160 x 2"	232	263	120.5	142.5	210.5	91.5	119	121	4.3 lbs
UCHF0.160075N	160 x 3"	232	263	120.5	142.5	227	91.5	135.5	122	4.4 lbs
UCHF0.200050N	200 x 2"	Coming	Soon							
UCHF0.200075N	200 x 3"	Coming	Soon							
UCHF0.250050N	250 x 2"	Coming	Soon							
UCHF0.200075N	250 x 3"	Coming	Soon							

Branch (pipe x pipe) 580 PSI (40 bar)

Part No.	Size Ømm	A	A1	A2	B	B1	B2	C	S	Weight
UCIC0.025020	25 x 20	113	76.5	36.5	70	52.5	17.5	33	29	5.8 oz
UCIC0.032020	32 x 20	126	83.5	42.5	81	59.5	21.5	33	29	6.6 oz
UCIC0.040020	40 x 20	142	94	48	100	73	27	38	29	12.3 oz
UCIC0.040025	40 x 25	143	95	48	100	73	27	38	36	11.4 oz
UCIC0.050020	50 x 20	150	94.5	55.5	112	80.5	31.5	38.5	29	13.7 oz
UCIC0.050025	50 x 25	150	94.5	55.5	112.5	80.5	31.5	38.5	36	1.3 lbs
UCIC0.063020	63 x 20	172	108	64	131.5	92	39.5	38	29	1.3 lbs
UCIC0.063025	63 x 25	174	110	64	131.5	92	39.5	38	36	1.2 lbs



Offset Nipple 1015 PSI (70 bar)

Part No.	G	A	B	C	F	S	Weight
UCMMG.015015	1/2" x 1/2"	56	40	20	20	19	.9 oz

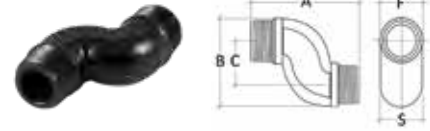

Wall Mounted Manifold 1015 PSI (70 bar)

Part No.	G	G1	Front Ports	A	B	D	All Ports	Weight
UCFFM.015015	1/2"	1/2"	1	50	56	-	4	7.1 oz
UCFFN.015015	1/2"	1/2"	2	102	56	46	5	15.3 oz
UCFFP.015015	1/2"	1/2"	4	154	56	34	7	1.4 lbs

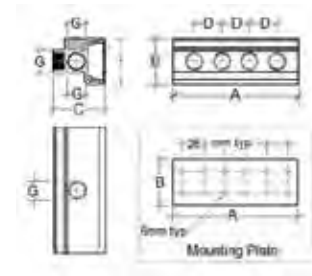

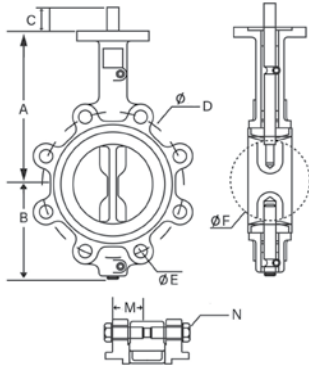

Butterfly Valves 225 PSI (15.5 bar)
Lug Style - Epoxy Coated Iron Body with EPDM Seal

Part No.	Size	A	B	C	D	F	M	N	Weight
PP703001	3"	7.13	3.74	1.26	6	3.1	1.5	5/8-11UNC	11 lbs
PP703002	4"	7.87	4.49	1.26	7.5	4.09	1.75	5/8-11UNC	20 lbs
PP703003	5"	8.39	5	1.26	8.5	4.85	1.75	3/4-10UNC	24 lbs
PP703004	6"	8.9	5.47	1.26	9.51	6.13	2	3/4-10UNC	31 lbs
PP703005	8"	10.24	6.89	1.61	11.75	7.97	2	3/4-10UNC	40 lbs
PP703006	10"	11.5	3.74	1.26	6	9.86	2.25	7/8-9UNC	59 lbs

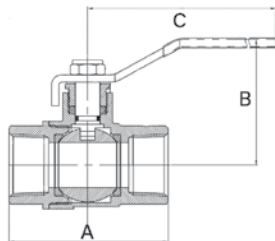

Brass Ball Valves - Male x Female 600 PSI (41 bar)

Part No.	Size	Description	A (in)	B (in)	C (in)	Weight
6510120	1/2" NPT	1/2" Male x Female, Full Flow Type	2.5	1.81	3.46	7.2 oz
6510160	3/4" NPT	3/4" Male x Female, Full Flow Type	3	2.09	4.29	12.3 oz
6510200	1" NPT	1" Male x Female, Full Flow Type	3.27	2.25	4.29	1.2 lbs

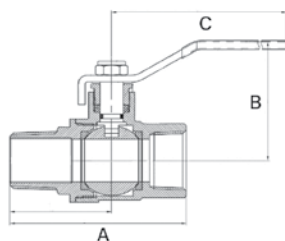

Brass Ball Valves - Female x Female 600 PSI (41 bar)

Part No.	Size	Description	A (in)	B (in)	C (in)	Weight
6510100	1/2" NPT	1/2" Female x Female, Full Flow Type	2.24	1.81	3.46	7 oz.
6510140	3/4" NPT	3/4" Female x Female, Full Flow Type	2.52	2.09	4.29	12 oz
6510180	1" NPT	1" Female x Female, Full Flow Type	2.97	2.25	4.29	1.1 lbs
6510220	1-1/4" NPT	1-1/4" Female x Female, Full Flow Type	3.44	2.52	5.63	1.7 lbs
6510240	1-1/2" NPT	1-1/2" Female x Female, Full Flow Type	3.88	2.74	5.63	2.3 lbs
6510260	2" NPT	2" Female x Female, Full Flow Type	4.3	3.03	5.63	3.4 lbs
6510270	2-1/2" NPT	2-1/2" Female x Female, Full Flow Type	5.53	4.25	7.76	7.4 lbs
6510280	3" NPT	3" Female x Female, Full Flow Type	6.14	4.58	8.19	9.9 lbs

Pipe Clips

Part No.	Size	Description	Weight
CL 20	20	Polypropylene Clip	.4 oz
CL 25	25	Polypropylene Clip	.5 oz
CL 32	32	Polypropylene Clip	.6 oz
CL 40	40	Polypropylene Clip	.7 oz
CL 50	50	Polypropylene Clip	.9 oz
CL 63	63	Polypropylene Clip	2.7 oz
HSBC20M10INS	20	Insulated Zinc Bolted Clip Head 3/8"	2.8 oz
HSBC25M10INS	25	Insulated Zinc Bolted Clip Head 3/8"	2.8 oz
HSBC32M10INS	32	Insulated Zinc Bolted Clip Head 3/8"	3.4 oz
HSBC40M10INS	40	Insulated Zinc Bolted Clip Head 3/8"	3.4 oz
HSBC50M10INS	50	Insulated Zinc Bolted Clip Head 3/8"	3.5 oz
HSBC63M10INS	63	Insulated Zinc Bolted Clip Head 3/8"	3.9 oz
HSBC75M10INS	75	Insulated Zinc Bolted Clip Head 3/8"	4.3 oz
HSBC90M10INS	90	Insulated Zinc Bolted Clip Head 3/8"	5.6 oz
HSBC108M10INS	110	Insulated Zinc Bolted Clip Head 3/8"	1.3 lbs
HSBC140M10INS	140	Insulated Zinc Bolted Clip Head 3/8"	Coming Soon
HSBC168M10INS	160	Insulated Zinc Bolted Clip Head 3/8"	1.5 lbs
HSBC200M10INS	200	Insulated Zinc Bolted Clip Head 3/8"	Coming Soon
HSBC250M10INS	250	Insulated Zinc Bolted Clip Head 3/8"	Coming Soon
HSCMP10	3/8"	Mounting Plate M10 Female	N/A
HSCMMP10	3/8"	Mounting Plate M10 Male	N/A
HSROD10	3/8"	Allthread Zinc Plated	N/A



Pipe Cutters

Part No.	Size mm	Description
PC35/SS	15 - 35	Rotary pipe cutter Cu/ Al /SS, built in deburrer
PC76/SS	15 - 76	Rotary pipe cutter Cu/ Al /SS, built in deburrer
PC140	54 - 108	Rotary pipe cutter Cu/ Al /SS, built in deburrer
PEC170E	15 - 170	Powerful, lightweight and handy PipeCut 170E can be used for cutting both metal and plastic pipes. Because of its adjustable speed and steady torque feature it is ideal for cutting aluminium or stainless steel. The gripper arms adjust to the pipe diameter and keep the cut square to the pipe.



Miscellaneous Tools

Part No.	Size mm	Description
TIU160	20 - 160	Depth gauge for marking correct insertion
TR05	15 - 54	Multi reamer inside and outside. Hand operated or with adaptor can be used with cordless drill
TRS05	15 - 54	Power tool adaptor for TR05
66980402	20 - 160	ID (Interior Diameter) Deburring Tool
66980503	20 - 160	OD (Outside Diameter) Deburring Tool



UnipipeNITRO Pipe 232 PSI (16 bar)

Part No.	Size Ømm	Size inches	Wall Thickness mm	Length m	Length Feet	Weight
UWTT0.020600	20	20	1.0	6	19.6	2 oz
UWTT0.025600	25	25	1.1	6	19.6	2.3 oz
UWTT0.032600	32	32	1.2	6	19.6	4.1 oz
UWTT0.040600	40	40	1.3	6	19.6	8.1 oz
UWTT0.050600	50	50	1.4	6	19.6	11.6 oz
UWTT0.063600	63	63	1.8	6	19.6	1.4 lbs



Straight Coupling 232 PSI (16 bar)

Part No.	Size Ømm	A	L	E	S	Weight
UWCC0.020020	20	70	35	37	29	2.5 oz
UWCC0.025025	25	75	37	42	36	3.4 oz
UWCC0.032032	32	94	46	51	43	6.1 oz
UWCC0.040040	40	117	57	63	53	11.9 oz
UWCC0.050050	50	138	68	78.5	66	1.2 lbs
UWCC0.063063	63	173	83	95	82	2.2 lbs



Sliding Straight Coupling 232 PSI (16 bar)

Part No.	Size Ømm	A	E	S	Weight
UWCC1.020020	20	70	37	29	2.5 oz
UWCC1.025025	25	75	42	36	3.4 oz
UWCC1.032032	32	94	51	33	6.1 oz
UWCC1.040040	40	117	63	53	11.9 oz
UWCC1.050050	50	138	78.5	66	1.2 lbs
UWCC1.063063	63	173	95	82	2.2 lbs



90° Elbow 232 PSI (16 bar)

Part No.	Size Ømm	A	E	L	S	Weight
UWCC9.020020	20	60	37	35	29	3 oz
UWCC9.025025	25	76	42	37	36	4 oz
UWCC9.032032	32	90	51	46	43	7.2 oz
UWCC9.040040	40	112	63	57	53	1.2 oz
UWCC9.050050	50	143	78.5	68	66	1.5 oz
UWCC9.063063	63	168	95	83	82	2.4 lbs

45° Elbow 232 PSI (16 bar)

Part No.	Size Ømm	A	B	E	L	S	Weight
UWCC4.020020	20	85	59	37	35	29	3.2 oz
UWCC4.025025	25	95	68	42	37	36	3.9 oz
UWCC4.032032	32	119	84	51	46	43	7.2 oz
UWCC4.040040	40	141	101	63	57	53	12 oz
UWCC4.050050	50	171	124	78.5	68	66	1.4 lbs
UWCC4.063063	63	207	150	95	83	82	2.3 lbs



Equal Tee 232 PSI (16 bar)

Part No.	Size Ømm	A	B	E	L	S	Weight
UWCCT.020020	20	101	68	37	35	29	4.3 oz
UWCCT.025025	25	111	75	42	37	36	5.7 oz
UWCCT.032032	32	136	93	51	46	43	10.3 oz
UWCCT.040040	40	162	110	63	57	53	1 lb
UWCCT.050050	50	206	141	78.5	68	66	2 lbs
UWCCT.063063	63	230	160	95	83	82	3.1 lbs
UWCCT.090090	90	306	217	132	93	118	7.5 lbs



Tee with FNPT Branch Line 232 PSI (16 bar)

Part No.	Size Ømm	A	B	E	L	S	Weight
UWCFT.020015	20 x 1/2" x 20	101	48	37	35	29	3.4 oz
UWCFT.025020	25 x 3/4" x 25	111	57	42	37	36	4.7 oz
UWCFT.032025	32 x 1" x 32	136	70	51	46	43	7.8 oz
UWCFT.040032	40 x 1 1/4" x 40	162	78	63	57	53	12.8 oz
UWCFT.050040	50 x 1 1/2" x 50	206	95	78.5	66	66	1.6 lbs
UWCFT.063050	63 x 2" x 63	230	114	95	83	82	2.5 lbs



90° Elbow with MNPT 232 PSI (16 bar)

Part No.	Size Ømm	A	B	E	L	S	Weight
UWCM9.020015N	20 x 1/2"	62	48	37	35	29	1.8 oz
UWCM9.025015N	25 x 1/2"	67	56	42	37	36	2.5 oz
UWCM9.025020N	25 x 3/4"	67	57	42	37	36	2.6 oz
UWCM9.032025N	32 x 1"	87	70	51	46	43	4.9 oz
UWCM9.040032N	40 x 1 1/4"	105	78	63	57	53	9 oz
UWCM9.040040N	40 x 1 1/2"	105	78	63	57	53	10 oz
UWCM9.040050N	40 x 2"	111	85	63	57	53	11 oz
UWCM9.050040N	50 x 1 1/2"	126	95	78.5	66	66	14.8 oz
UWCM9.063050N	63 x 2"	159	114	95	83	82	1.8 lbs



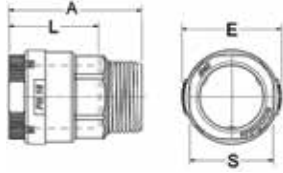

MNPT Adapter 232 PSI (16 bar)

Part No.	Size Ømm	A	E	S	L	Weight
UWCM0.020015N	20 x 1/2"	49	37	29	35	1.4 oz
UWCM0.020020N	20 x 3/4"	51.5	37	29	35	1.4 oz
UWCM0.025015N	25 x 1/2"	55	42	36	37	2 oz
UWCM0.025020N	25 x 3/4"	55	42	36	37	2 oz
UWCM0.025025N	25 x 1"	60.5	42	36	37	2 oz
UWCM0.032025N	32 x 1"	68	51	43	46	3.9 oz
UWCM0.032032N	32 x 1 1/4"	70	51	43	46	3.9 oz
UWCM0.040032N	40 x 1 1/4"	81	63	53	57	6.5 oz
UWCM0.040040N	40 x 1 1/2"	81	63	53	57	6.5 oz
UWCM0.050040N	50 x 1 1/2"	92	78.5	66	68	11.2 oz
UWCM0.050050N	50 x 2"	95.5	78.5	66	68	11.2 oz
UWCM0.063050N	63 x 2"	119	95	82	83	1.2 lbs
UWCM0.063063N	63 x 2 1/2"	121	95	82	83	1.2 lbs

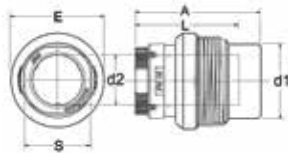

Reducer - (fitting x pipe) 232 PSI (16 bar)

Part No.	Size fitting d1 Ømm	Size outlet d2 Ømm	A	E	L	S	Weight
UWSC0.025020	25	20	46	33	35	29	1.8 oz
UWSC0.032025	32	25	52.6	42	37	36	2.9 oz
UWSC0.040020	40	20	59.5	52	35	29	5.4 oz
UWSC0.040025	40	25	60.6	52	37	36	6.1 oz
UWSC0.040032	40	32	54.6	52	46	43	4.2 oz
UWSC0.050040	50	40	73	64.8	57	53	8.5 oz
UWSC0.063040	63	40	86.3	79.5	57	53	13.9 oz
UWSC0.063050	63	50	84	79.5	68	66	14.7 oz

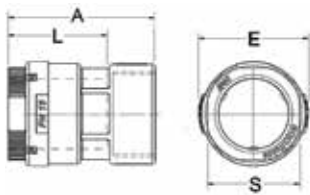

FNPT Adapter 232 PSI (16 bar)

Part No.	Size Ømm	A	E	L	S	Weight
UWCF0.020015N	20 x 1/2"	55	37	35	29	2 oz
UWCF0.025020N	25 x 3/4"	57	42	37	36	2.3 oz
UWCF0.032025N	32 x 1"	69	51	46	43	4.1 oz
UWCF0.040032N	40 x 1 1/4"	80	63	57	53	8.1 oz
UWCF0.050040N	50 x 1 1/2"	95	78	66	66	11.6 oz
UWCF0.063050N	63 x 2"	120	95	83	82	1.4 lbs

Ball Valve (pipe x pipe) 232 PSI (16 bar)

Part No.	Pipe - Pipe Ømm	A	B	E	G	L	S	Weight
UACCV.020020	20	131	73	40	99	35	35	8.1 oz
UACCV.025020	25 x 20	131	73	40	102	37	37	8.4 oz
UACCV.025025	25	150	87	50	110.5	37	37	13.4 oz
UACCV.032032	32	203	111	61	137	46	46	1.5 lbs
UACCV.040040	40	213	121	72	169	57	57	2.1 lbs
UACCV.050050	50	282	156	89	200	68	68	3.5 lbs
UACCV.063063	63	306	176	109	253.5	83	83	6 lbs

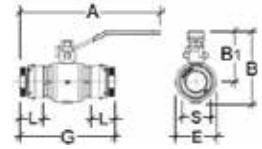

Ball Valve - (pipe x MNPT) 232 PSI (16 bar)

Part No.	Pipe Ømm - Thread	A	B	E	G	L	S	Weight
UACMV.020015N	20 x 1/2"	131	73	40	94	35	29	7.4 oz
UACMV.025020N	25 x 3/4"	150	87	50	104.5	37	36	12.2 oz
UACMV.032025N	32 x 1"	203	111	61	132	46	43	1.3 lbs
UACMV.040032N	40 x 1 1/4"	213	121	72	145.5	57	53	1.9 lbs
UACMV.050040N	50 x 1 1/2"	282	156	89	187.5	68	66	3.2 lbs
UACMV.063050N	63 x 2"	306	176	109	217	83	82	5.5 lbs

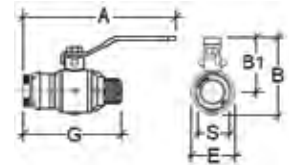

Three Way Ball Valve 232 PSI (16 bar)

Part No.	Pipe Ømm	A	B	E	G	L	S
UACCVT.032032	32	Coming	Soon				
UACCVT.040040	40	Coming	Soon				
UACCVT.050050	50	Coming	Soon				



Wall Mounted Drop End 232 PSI (16 bar)

Part No.	Inlet Ømm spigot	Outlet G	No of outlets	A	B	F	G	M	Weight
UASFS.025015	25	1/2"	1	99	72	6	24	83	5.1 oz
UASFD.025015	25	1/2"	2	99	72	6	24	83	5.7 oz

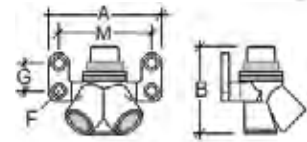

UnipipeVAC Pipe -29 inHg (-0.87 bar)



Part No.	Size Ømm	Size Inches	Wall Thickness mm	Length m	Length Feet	Weight
UVTT0.020600	20	3/4"	1.0	6	19.6	2.1 lbs.
UVTT0.025600	25	1"	1.1	6	19.6	2.9 lbs.
UVTT0.032600	32	1-1/4"	1.2	6	19.6	4.1 lbs.
UVTT0.040600	40	1-1/2"	1.3	6	19.6	5.7 lbs.
UVTT0.050600	50	2"	1.4	6	19.6	7.7 lbs.
UVTT0.063600	63	2-1/2"	1.8	6	19.6	12.4 lbs.
UVTT0.075600	75	3"	2	6	19.6	17.9 lbs.
UVTT0.090600	90	3-1/2"	2.4	6	19.6	23.8 lbs.
UVTT0.110600	110	4-1/2"	3.0	6	19.6	35.7 lbs.
UVTT0.140600	140	5"	2.8	6	19.6	44.7 lbs.
UVTT0.160600	160	6"	4.3	6	19.6	75.4 lbs.
UVTT0.200600	200	8"	4	6	19.6	89.3 lbs.
UVTT0.250600	250	10"	5	6	19.6	141 lbs.

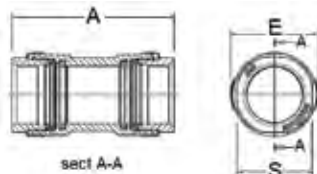
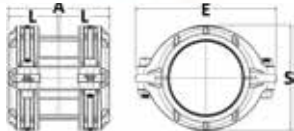
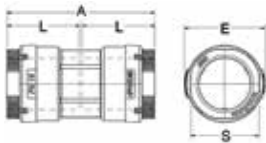

Straight Coupling -29 inHg (-0.87 bar)

Part No.	Size Ømm	A	L	E	S	Weight
UVCC0.020020	20	70	35	37	29	2.5 oz
UVCC0.025025	25	75	37	42	36	3.4 oz
UVCC0.032032	32	94	46	51	43	6.1 oz
UVCC0.040040	40	117	57	63	53	11.9 oz
UVCC0.050050	50	138	68	78.5	66	1.2 lbs
UVCC0.063063	63	173	83	95	82	2.2 lbs
UVCC0.075075	75	174	85.4	108	100	2.4 lbs
UVCC0.090090	90	190	93	132	118	3.9 lbs
UVCC0.110110	110	150	73	206	154	4.8 lbs
UVCC0.140140	140	Coming	Soon			
UVCC0.160160	160	272	133.5	266	221	17.2 lbs
UVCC0.200200	200	Coming	Soon			
UVCC0.250250	250	Coming	Soon			

Sliding Straight Coupling -29 inHg (-0.87 bar)

Part No.	Size Ømm	A	E	S	Weight
UVCC1.020020	20	70	37	29	2.5 oz
UVCC1.025025	25	75	42	36	3.4 oz
UVCC1.032032	32	94	51	33	6.1 oz
UVCC1.040040	40	117	63	53	11.9 oz
UVCC1.050050	50	138	78.5	66	1.2 lbs
UVCC1.063063	63	173	95	82	2.2 lbs
UVCC1.075075	75	174	108	100	2.4 lbs
UVCC1.090090	90	190	132	118	3.9 lbs

90° Elbow -29 inHg (-0.87 bar)

Part No.	Size Ømm	A	E	L	S	Weight
UVCC9.020020	20	60	37	35	29	3 oz
UVCC9.025025	25	76	42	37	36	4 oz
UVCC9.032032	32	90	51	46	43	7.2 oz
UVCC9.040040	40	112	63	57	53	1.2 oz
UVCC9.050050	50	143	78.5	68	66	1.5 oz
UVCC9.063063	63	168	95	83	82	2.4 lbs
UVCC9.075075	75	189.5	108	85.4	100	2.8 lbs
UVCC9.090090	90	219	132	93	118	5.5 lbs
UVCC9.110110	110	214	206	73	154	7.6 lbs
UVCC9.140140	140	Coming	Soon			
UVCC9.160160	160	352	266	133.5	221	25.2 lbs
UVCC9.200200	200	Coming	Soon			
UVCC9.250250	250	Coming	Soon			

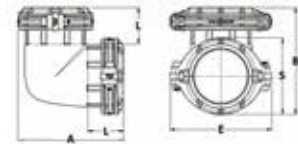
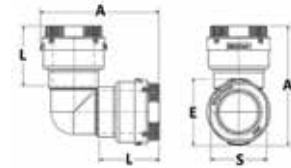

45° Elbow -29 inHg (-0.87 bar)

Part No.	Size Ømm	A	B	E	L	S	Weight
UVCC4.020020	20	85	59	37	35	29	3.2 oz
UVCC4.025025	25	95	68	42	37	36	3.9 oz
UVCC4.032032	32	119	84	51	46	43	7.2 oz
UVCC4.040040	40	141	101	63	57	53	12 oz
UVCC4.050050	50	171	124	78.5	68	66	1.4 lbs
UVCC4.063063	63	207	150	95	83	82	2.3 lbs

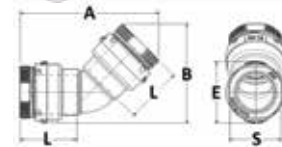

Equal Tee -29 inHg (-0.87 bar)

Part No.	Size Ømm	A	B	E	L	S	Weight
UVCCT.020020	20	101	68	37	35	29	4.3 oz
UVCCT.025025	25	111	75	42	37	36	5.7 oz
UVCCT.032032	32	136	93	51	46	43	10.3 oz
UVCCT.040040	40	162	110	63	57	53	1 lb
UVCCT.050050	50	206	141	78.5	68	66	2 lbs
UVCCT.063063	63	230	160	95	83	82	3.1 lbs
UVCCT.075075	75	260	219.9	108	85.4	100	4 lbs
UVCCT.090090	90	306	217	132	93	118	7.5 lbs
UVCCT.110110	110	277	214	206	73	154	10 lbs
UVCCT.140140	140	Coming	Soon				
UVCCT.160160	160	484	352	265	133.5	221	36.7 lbs
UVCCT.200200	200	Coming	Soon				
UVCCT.250250	250	Coming	Soon				

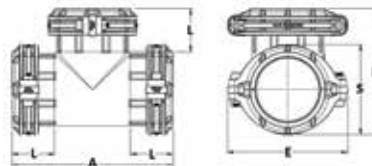

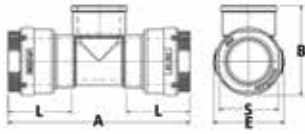

Tee with FNPT Branch Line -29 inHg (-0.87 bar)

Part No.	Size Ømm	A	B	E	L	S	Weight
UVCFT.020015N	20 x 1/2" x 20	101	48	37	35	29	3.4 oz
UVCFT.025020N	25 x 3/4" x 25	111	57	42	37	36	4.7 oz
UVCFT.032025N	32 x 1" x 32	136	70	51	46	43	7.8 oz
UVCFT.040032N	40 x 1 1/4" x 40	162	78	63	57	53	12.8 oz
UVCFT.050040N	50 x 1 1/2" x 50	206	95	78.5	66	66	1.6 lbs
UVCFT.063050N	63 x 2" x 63	230	114	95	83	82	2.5 lbs

90° Elbow with MNPT -29 inHg (-0.87 bar)

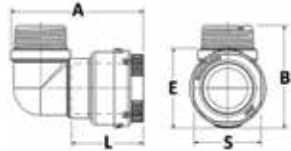

Part No.	Size Ømm	A	B	E	L	S	Weight
UVCM9.020015N	20 x 1/2"	62	48	37	35	29	1.8 oz
UVCM9.025015N	25 x 1/2"	67	57	42	37	36	2.6 oz
UVCM9.025020N	25 x 3/4"	67	57	42	37	36	2.6 oz
UVCM9.032025N	32 x 1"	87	70	51	46	43	4.9 oz
UVCM9.040032N	40 x 1 1/4"	105	78	63	57	53	9 oz
UVCM9.040040N	40 x 1 1/2"	105	78	63	57	53	10 oz
UVCM9.040050N	40 x 2"	111	85	63	57	53	11 oz
UVCM9.050040N	50 x 1 1/2"	126	95	78.5	66	66	14.8 oz
UVCM9.063050N	63 x 2"	159	114	95	83	82	1.8 lbs

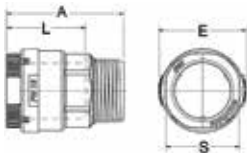

MNPT Adapter -29 inHg (-0.87 bar)

Part No.	Size Ømm	A	E	S	L	Weight
UVCM0.020015N	20 x 1/2"	49	37	29	35	1.4 oz
UVCM0.020020N	20 x 3/4"	51.5	37	29	35	1.4 oz
UVCM0.025015N	25 x 1/2"	55	42	36	37	2 oz
UVCM0.025020N	25 x 3/4"	55	42	36	37	2 oz
UVCM0.025025N	25 x 1"	60.5	42	36	37	2 oz
UVCM0.032025N	32 x 1"	68	51	43	46	3.9 oz
UVCM0.032032N	32 x 1 1/4"	70	51	43	46	3.9 oz
UVCM0.040032N	40 x 1 1/4"	81	63	53	57	6.5 oz
UVCM0.040040N	40 x 1 1/2"	81	63	53	57	6.5 oz
UVCM0.050040N	50 x 1 1/2"	92	78.5	66	68	11.2 oz
UVCM0.050050N	50 x 2"	95.5	78.5	66	68	11.2 oz
UVCM0.063050N	63 x 2"	119	95	82	83	1.2 lbs
UVCM0.063063N	63 x 2 1/2"	121	95	82	83	1.2 lbs
UVCM0.075075N	75 x 2 1/2"	122.9	108	100	85.4	1.4 lbs
UVCM0.090075N	90 x 3"	130	132	118	93	2.2 lbs

FNPT Adapter -29 inHg (-0.87 bar)

Part No.	Size Ømm	A	E	L	S	Weight
UVCF0.020015N	20 x 1/2"	55	37	35	29	2 oz
UVCF0.025020N	25 x 3/4"	57	42	37	36	2.3 oz
UVCF0.032025N	32 x 1"	69	51	46	43	4.1 oz
UVCF0.040032N	40 x 1 1/4"	80	63	57	53	8.1 oz
UVCF0.050040N	50 x 1 1/2"	95	78	66	66	11.6 oz
UVCF0.063050N	63 x 2"	120	95	83	82	1.4 lbs



Flange Adapter -29 inHg (-0.87 bar)

Part No.	Size Ømm	A	B	E	F	G	M	L	S	Weight
UVCJF.090075	90 x 3"	Coming	Soon							
UVCJF.110100	110 x 4"	99	73	206	18	220	180	75	154	5.5 lbs
UACJF.140125	140 x 5"	Coming	Soon							
UVCJF.160150	160 x 6"	184	171	221	23.5	283	240.5	133.5	221	16.4 lbs
UACJF.200200	200 x 8"	Coming	Soon							
UACJF.250250	250 x 10"	Coming	Soon							



Special Flange (fitting x flange adapter) Elbow or Tee -29 inHg (-0.87 bar)

Part No.	Pipe Size	Flange Description	A	B	F	M	S
UVSC0.110100	100	DN100 - 4"	220	*	18	180	*
UVSC0.110101	140	DN125 - 5"	Coming	Soon			
UVSC0.160150	160	DN150 - 6"	283	39	23.5	240.5	186
UVSC0.160151	200	DN200 - 8"	Coming	Soon			
UVSC0.160152	250	DN250 - 10"	Coming	Soon			

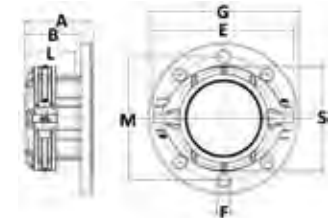

Reducer (fitting x pipe) -29 inHg (-0.87 bar)

Part No.	Size fitting d1 Ømm	Size outlet d2 Ømm	A	E	L	S	Weight
UVSC0.025020	25	20	46	33	35	29	1.8 oz
UVSC0.032025	32	25	52.6	42	37	36	2.9 oz
UVSC0.040020	40	20	59.5	52	35	29	5.4 oz
UVSC0.040025	40	25	60.6	52	37	36	6.1 oz
UVSC0.040032	40	32	54.6	52	46	43	4.2 oz
UVSC0.050040	50	40	73	64.8	57	53	8.5 oz
UVSC0.063040	63	40	86.3	79.5	57	53	13.9 oz
UVSC0.063050	63	50	84	79.5	68	66	14.7 oz
UVSC0.063050	75	63	93.5	108	85.4	100	
UVSC0.090063	90	63	111.8	114	83	82	2.5 lbs
UVSC0.110090	110	90	117	123	93	118	2.8 lbs
	140	Coming	Soon				
UVSC0.160110	160	110	175	200	73	154	5.7 lbs
	200	Coming	Soon				
	250	Coming	Soon				

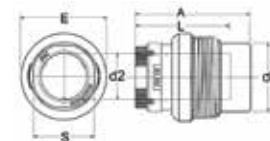
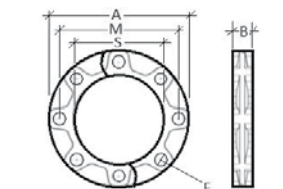



Ball Valve (pipe x pipe) -29 inHg (-0.87 bar)

Part No.	Pipe - Pipe Ømm	A	B	E	G	L	S	Weight
UACCV.020020	20	131	73	40	99	35	35	8.1 oz
UACCV.025020	25 x 20	131	73	40	102	37	37	8.4 oz
UACCV.025025	25	150	87	50	110.5	37	37	13.4 oz
UACCV.032032	32	203	111	61	137	46	46	1.5 lbs
UACCV.040040	40	213	121	72	169	57	57	2.1 lbs
UACCV.050050	50	282	156	89	200	68	68	3.5 lbs
UACCV.063063	63	306	176	109	253.5	83	83	6 lbs



Ball Valve - (pipe x MNPT) -29 inHg (-0.87 bar)

Part No.	Pipe Ømm - Thread	A	B	E	G	L	S	Weight
UACMV.020015N	20 x 1/2"	131	73	40	94	35	29	7.4 oz
UACMV.025020N	25 x 3/4"	150	87	50	104.5	37	36	12.2 oz
UACMV.032025N	32 x 1"	203	111	61	132	46	43	1.3 lbs
UACMV.040032N	40 x 1 1/4"	213	121	72	145.5	57	53	1.9 lbs
UACMV.050040N	50 x 1 1/2"	282	156	89	187.5	68	66	3.2 lbs
UACMV.063050N	63 x 2"	306	176	109	217	83	82	5.5 lbs



Three Way Ball Valve -29 inHg (-0.87 bar)

Part No.	Pipe Ømm	A	B	E	G	L	S
UACCVT.032032	32	Coming	Soon				
UACCVT.040040	40	Coming	Soon				
UACCVT.050050	50	Coming	Soon				



Wall Mounted Drop End -29 inHg (-0.87 bar)

Part No.	Inlet Ømm spigot	Outlet G	No of outlets	A	B	F	G	M	Weight
UASFS.025015	25	1/2"	1	99	72	6	24	83	5.1 oz
UASFD.025015	25	1/2"	2	99	72	6	24	83	5.7 oz

UnipipeHP Pipe 1015 PSI (70 bar)

Part No.	Size Ømm	Wall Thickness mm	psi	Length m	Length Feet	Weight
UCTT0.020400	20	2.0	1015	4	13	2.1 lbs
UCTT0.025400	25	2.5	1015	4	13	2.9 lbs
UCTT0.032400	32	3.0	1015	4	13	4.1 lbs
UCTT0.040400	40	4.0	1015	4	13	5.7 lbs
UCTT0.050400	50	5.0	1015	4	13	7.7 lbs
UCTT0.063400	63	6.0	1015	4	13	12.4 lbs



Straight Coupling 1015 PSI (70 bar)

Part No.	Size Ømm	bar	A	L	E	S	Weight
UCCC0.020020	20	70	70	35	37	29	2.5 oz
UCCC0.025025	25	70	75	37	42	36	3.4 oz
UCCC0.032032	32	70	94	46	51	43	6.1 oz
UCCC0.040040	40	70	117	57	63	53	11.9 oz
UCCC0.050050	50	70	138	68	78.5	66	1.2 lbs
UCCC0.063063	63	70	173	83	95	82	2.2 lbs



Sliding Straight Coupling 1015 PSI (70 bar)

Part No.	Size Ømm	A	E	S	Weight
UCCC1.020020	20	70	37	29	2.5 oz
UCCC1.025025	25	75	42	36	3.4 oz
UCCC1.032032	32	94	51	33	6.1 oz
UCCC1.040040	40	117	63	53	11.9 oz
UCCC1.050050	50	138	78.5	66	1.2 lbs
UCCC1.063063	63	173	95	82	2.2 lbs



90° Elbow 1015 PSI (70 bar)

Part No.	Size Ømm	A	E	L	S	Weight
UCCC9.020020	20	60	37	35	29	3 oz
UCCC9.025025	25	76	42	37	36	4 oz
UCCC9.032032	32	90	51	46	43	7.2 oz
UCCC9.040040	40	112	63	57	53	1.2 oz
UCCC9.050050	50	143	78.5	68	66	1.5 oz
UCCC9.063063	63	168	95	83	82	2.4 lbs





45° Elbow 1015 PSI (70 bar)

Part No.	Size Ømm	A	B	E	L	S	Weight
UCCC4.020020	20	85	59	37	35	29	3.2 oz
UCCC4.025025	25	95	68	42	37	36	3.9 oz
UCCC4.032032	32	119	84	51	46	43	7.2 oz
UCCC4.040040	40	141	101	63	57	53	12 oz
UCCC4.050050	50	171	124	78.5	68	66	1.4 lbs
UCCC4.063063	63	207	150	95	83	82	2.3 lbs



Equal Tee 1015 PSI (70 bar)

Part No.	Size Ømm	A	B	E	L	S	Weight
UCCCT.020020	20	101	68	37	35	29	4.3 oz
UCCCT.025025	25	111	75	42	37	36	5.7 oz
UCCCT.032032	32	136	93	51	46	43	10.3 oz
UCCCT.040040	40	162	110	63	57	53	1 lb
UCCCT.050050	50	206	141	78.5	68	66	2 lbs
UCCCT.063063	63	230	160	95	83	82	3.1 lbs



Tee with FNPT Branch Line 1015 PSI (70 bar)

Part No.	Size Ømm	A	B	E	L	S	Weight
UCCFT.020015N	20 x 1/2" x 20	101	48	37	35	29	3.4 oz
UCCFT.025020N	25 x 3/4" x 25	111	57	42	37	36	4.7 oz
UCCFT.032025N	32 x 1" x 32	136	70	51	46	43	7.8 oz
UCCFT.040032N	40 x 1 1/4" x 40	162	78	63	57	53	12.8 oz
UCCFT.050040N	50 x 1 1/2" x 50	206	95	78.5	66	66	1.6 lbs
UCCFT.063050N	63 x 2" x 63	230	114	95	83	82	2.5 lbs



90° Elbow with MNPT 1015 PSI (70 bar)

Part No.	Size Ømm	A	B	E	L	S	Weight
UCCM9.020015N	20 x 1/2"	62	48	37	35	29	1.8 oz
UCCM9.025015N	25 x 1/2"	67	57	42	37	36	2.6 oz
UCCM9.025020N	25 x 3/4"	67	57	42	37	36	2.6 oz
UCCM9.032025N	32 x 1"	87	70	51	46	43	4.9 oz
UCCM9.040032N	40 x 1 1/4"	105	78	63	57	53	9 oz
UCCM9.040040N	40 x 1 1/2"	105	78	63	57	53	10 oz
UCCM9.040050N	40 x 2"	111	85	63	57	53	11 oz
UCCM9.050040N	50 x 1 1/2"	126	95	78.5	66	66	14.8 oz
UCCM9.063050N	63 x 2"	159	114	95	83	82	1.8 lbs

MNPT Adapter 1015 PSI (70 bar)

Part No.	Size Ømm	A	E	S	L	Weight
UCCM0.020015N	20 x 1/2"	49	37	29	35	1.4 oz
UCCM0.020020N	20 x 3/4"	51.5	37	29	35	1.4 oz
UCCM0.025015N	20 x 1/2"	55	42	36	37	2 oz
UCCM0.025020N	25 x 3/4"	55	42	36	37	2 oz
UCCM0.025025N	25 x 1"	60.5	42	36	37	2 oz
UCCM0.032025N	32 x 1"	68	51	43	46	3.9 oz
UCCM0.032032N	32 x 1 1/4"	70	51	43	46	3.9 oz
UCCM0.040032N	40 x 1 1/4"	81	63	53	57	6.5 oz
UCCM0.040040N	40 x 1 1/2"	81	63	53	57	6.5 oz
UCCM0.050040N	50 x 1 1/2"	92	78.5	66	68	11.2 oz
UCCM0.050050N	50 x 2"	95.5	78.5	66	68	11.2 oz
UCCM0.063050N	63 x 2"	119	95	82	83	1.2 lbs
UCCM0.063065N	63 x 2 1/2"	121	95	82	83	1.2 lbs

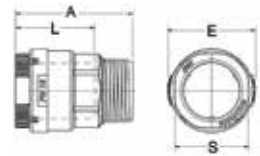

FNPT Adapter 1015 PSI (70 bar)

Part No.	Size Ømm	A	E	L	S	Weight
UCCF0.020015	20 x 1/2"	55	37	35	29	2 oz
UCCF0.025020	25 x 3/4"	57	42	37	36	2.3 oz
UCCF0.032025	32 x 1"	69	51	46	43	4.1 oz
UCCF0.040032	40 x 1 1/4"	80	63	57	53	8.1 oz
UCCF0.050040	50 x 1 1/2"	95	78	66	66	11.6 oz
UCCF0.063050	63 x 2"	120	95	83	82	1.4 lbs

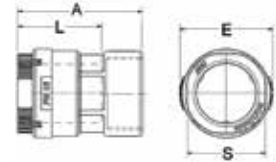

Reducer (fitting x pipe) 1015 PSI (70 bar)

Part No.	Size fitting d1 Ømm	Size outlet d2 Ømm	A	E	L	S	Weight
UCSC0.025020	25	20	46	33	35	29	1.8 oz
UCSC0.032025	32	25	52.6	42	37	36	2.9 oz
UCSC0.040020	40	20	59.5	52	35	29	5.4 oz
UCSC0.040025	40	25	60.6	52	37	36	6.1 oz
UCSC0.040032	40	32	54.6	52	46	43	4.2 oz
UCSC0.050040	50	40	73	64.8	57	53	8.5 oz
UCSC0.063040	63	40	86.3	79.5	57	53	13.9 oz
UCSC0.063050	63	50	84	79.5	68	66	14.7 oz

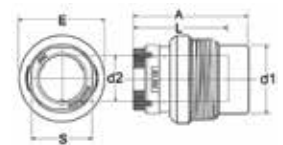



HP Ball Valve (pipe x pipe) 1015 PSI (70 bar)

Part No.	Pipe - Pipe Ømm	A	B	E	G	L	S	Weight
UCC.020020	20	131	73	40	99	35	35	8.1 oz
UCC.025020	25 x 20	131	73	40	102	37	37	8.4 oz
UCC.025025	25	150	87	50	110.5	37	37	13.4 oz
UCC.032032	32	203	111	61	137	46	46	1.5 lbs
UCC.040040	40	213	121	72	169	57	57	2.1 lbs
UCC.050050	50	282	156	89	200	68	68	3.5 lbs
UCC.063063	63	306	176	109	253.5	83	83	6 lbs



HP Ball Valve - (pipe x MNPT) 1015 PSI (70 bar)

Part No.	Pipe Ømm - Thread	A	B	E	G	L	S	Weight
UCC.020015N	20 x 1/2"	131	73	40	94	35	29	7.4 oz
UCC.025020N	25 x 3/4"	150	87	50	104.5	37	36	12.2 oz
UCC.032025N	32 x 1"	203	111	61	132	46	43	1.3 lbs
UCC.040032N	40 x 1 1/4"	213	121	72	145.5	57	53	1.9 lbs
UCC.050040N	50 x 1 1/2"	282	156	89	187.5	68	66	3.2 lbs
UCC.063050N	63 x 2"	306	176	109	217	83	82	5.5 lbs

Four Options - Many Applications

- No Special Tools Required
- High-Pressure Capacity
- Vast Temperature Capabilities
- Quick & Easy
- Flexible & Universal



Install Special Flange Coupler • Elbow • Tee 4-1/2 to 10" (110mm - 250mm)



Typical application of Fitting Flange converting an Elbow and a Tee to Flanged connection.



Remove the bolts, clamp ring halves and the Grip Ring leaving the end of the fitting ready for the Fitting Flange.



Fit both halves of the Fitting Flange behind the face of the body, ready to install where needed.

Install Reducer Coupler • Elbow • Tee 1" to 3-1/2" (25mm - 90mm)



Unscrew the nut and remove the grip ring and identification collar.



Insert and tighten the reducer in the desired position.

Install Reducer in Fitting Coupler • Elbow • Tee 4-1/2" to 10" (110mm-250mm)



Remove the bolts, clamp ring halves and the Grip Ring leaving the end of the fitting ready for the Reducer. Discard the grip ring.



Insert the Reducer in the desired position, reassemble the clamp halves and tighten the bolts and nuts at a torque value of 11 lb-ft.

Install Plug in Fitting Coupler • Elbow • Tee 1" to 3-1/2" (25mm-90mm)



Unscrew the nut and remove the grip ring and identification collar. Discard the grip ring.



Insert the Plug into the fitting. Reassemble the identification ring and firmly tighten the nut.

Install Branch 1" to 3-1/2" (25mm-63mm)



- 1. Clamp Half
- 2. Fixed Seal
- 3. Branch Body
- 4. Clamp Bolt
- 5. Plug
- 6. Grip Ring
- 7. Identification Collar
- 8. Nut



1 Verify the section of pipe where the branch is to be installed is free from scratches or dents.

Completely unscrew the clamp bolt. Separate the clamp half by sliding it sideways from the body.



2 Position the main branch body in its correct position, making sure the seal is correctly located.

Slide the clamp half back into the fitting, lining up the screw holes.

Adjust branch to its final position and tighten the bolt.



3 Unscrew the plug.



4 Drill hole in pipe using a hole saw matched for a clearance fit on the diameter of the inner hole.

Carefully deburr edges of hole and remove all swarf.

Branch Size	Hole Saw Size
25	1/2" (14mm)
32	1/2" (14mm)
40	3/4" (19mm)
50	3/4" (19mm)
63	3/4" (19mm)



5 Replace plug and tighten.

Insert Branch line following standard procedures.

Install Saddle Branch 1" to 10" (25mm-250mm)



1 Completely remove the bolt.
Slide the clamp half to one side until it is free.
Check the seal is in place in the Saddle Branch body.



2 Place the Saddle Branch body in its approximate position.
Slide the clamp half into the body.
Check final position then insert bolt and tighten.

Branch Size	Hole Saw Size
1/2"	1/2" (14mm)
3/4"	3/4" (19mm)
1"	1" (24mm)
2"	2" (48mm)
3"	3" (79mm)



3 Drill hole in pipe using a hole saw matched for a clearance fit on the diameter of the inner hole.
Carefully deburr edges of hole and remove all metal shavings.



Typical Application for Saddle Branch



1. Saddle Branch Body
2. Saddle Clamp Half
3. Gasket Seal
4. Washer
5. Socket Head Bolt

Unipipe Assembly Instructions 3/4" to 3-1/2" (20mm-90mm)



1 CUTTING: Cut the pipe using burr-free approved cutters. Do not use oxy-acetylene or abrasive cut off wheels.

Pipes must be cut at right angles to their axis, using a pipe cutter or fine-tooth saw, allowing for the depth of insertion into the fitting.



2 DEBURRING: All pipe cuts must be carefully deburred, both inside and outside, using a manual or electric deburring tool. Any cutting residue (swarf) must be removed to avoid damage to the O-ring when the pipe is inserted into the fitting, avoiding possible leaks.



3 MARK INSERTION DEPTH:

To ensure a correctly inserted joint, the pipe must be marked with a fine-point marker to show the insertion depth in the fitting, or by measurement using the table below. The use of a Unipipe Depth Gauge is recommended.

Insertion Depth

Pipe Diameter	20mm	25mm	32mm	40mm	50mm	63mm	75mm	90mm
Distance From End	35mm	37mm	46mm	57mm	68mm	83mm	86mm	93mm

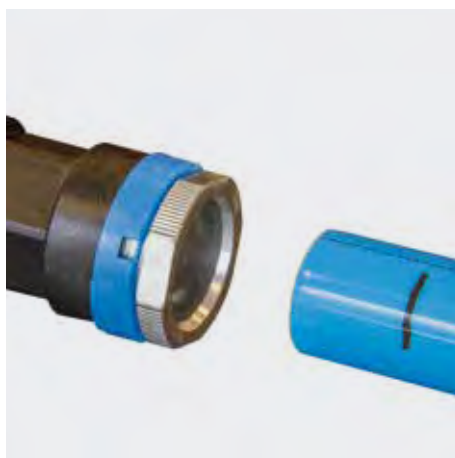

4 LOOSEN NUT: Check that all components are correctly positioned inside the fitting.



5 LUBRICATION: Use soapy water, silicone spray or a lubricant that is compatible with the intended use. Lubrication is optional, but will assist inserting the pipe through the seal ring. Do not use silicone spray if intended use is for powder coating, spray painting or breathing air.



6 INSERT and TIGHTEN: Insert the pipe up to the mark, ensuring the axis of the pipe and the fitting are straight. Tighten the nut by hand and then with a wrench for 1/4-turn more or until the pipe starts to turn. DO NOT OVERTIGHTEN.

Unipipe Assembly Instructions 4-1/2" to 10" (110mm-250mm)



1 CUTTING: Cut the pipe using burr-free approved cutters. Do not use oxy-acetylene or abrasive cut off wheels. Pipes must be cut at right angles to their axis, using a pipe cutter or fine-tooth saw, allowing for the depth of insertion into the fitting.



2 DEBURRING: All pipe cuts must be carefully deburred, both inside and outside, using a manual or electric deburring tool. Any cutting residue (swarf) must be removed to preclude damage to the O-ring when the pipe is inserted into the fitting, avoiding possible leaks.



3 MARK INSERTION DEPTH: To ensure a correctly inserted joint, the pipe must be marked with a fine-point marker to show the insertion depth in the fitting, or by measurement using the table below. The use of a Unipipe Depth Gauge is recommended.

Insertion Depth

Pipe Diameter	110mm	140mm	160mm	200mm	250mm
Distance From End	73mm	92mm	134mm	Coming Soon	Coming Soon



4 LOOSEN NUT: Loosen the nuts of the relevant clamp halves.



5 LUBRICATION: Use soapy water, silicone spray or a lubricant that is compatible with the intended use. Lubrication is optional, but will assist inserting the pipe through the seal ring. Do not use silicone spray if intended use is for powder coating, spray painting or breathing air.



6 INSERT and TIGHTEN: Insert the pipe into the fitting up to the depth mark, ensuring the axis of the pipe and the fitting are straight. Tighten the bolts with a spanner to a torque value of 11 lb-ft.

Site Plan





Unipipe is offered with a warranty against defects in manufacturing or materials. It remains the responsibility of the user to ensure that the fittings and related products are suitable for the application. The installation must be carried out by a competent person in accordance with the enclosed recommendations, complying with recognized codes of practice and relevant standards, and be properly maintained. Refer to our terms and conditions.

Unipipe has a policy of continuous improvement, research, and development. We reserve the right to amend the specifications and design of all products without notice.

unipipe™

550 Albion Avenue Suite 100
Schaumburg, IL 60193
888.966.9007

www.UnipipeSolutions.com