

Instruction and operation manual

S132

Laser particle counter



Dear Customer,

Thank you for choosing our product.

Before you start up the device please read this manual in full and carefully observe instructions stated in this manual. The manufacturer cannot be held liable for any damage that occurs as a result of non-observance or non-compliance with this manual.

Should the device be tampered with in any manner other than a procedure that is described and specified in the manual, the warranty is void and the manufacturer is exempt from liability.

The device is destined exclusively for the described application.

SUTO offers no guarantee for the suitability for any other purpose. SUTO is also not liable for consequential damage resulting from the delivery, capability or use of this device.

Table of Contents

1	Safety instructions.....	4
2	Application.....	7
3	Features.....	7
4	Technical data.....	8
4.1	General data.....	8
4.2	Electrical data.....	8
4.3	Output signals.....	9
4.4	Counting efficiency.....	9
4.5	Procedure of general particle counting	9
5	Dimensional drawing.....	10
6	Installation	11
6.1	Installation requirements.....	11
6.2	Installation procedure	13
6.3	Electrical connection.....	14
7	Configuration	16
7.1	Integrated display.....	16
7.2	Service kit.....	16
7.3	External display	16
8	Operation using the integrated display.....	17
8.1	Value view.....	17
8.1.1	Icons in the status bar.....	18
8.2	Trend view.....	19
8.3	Menu.....	20
8.4	Sensor settings.....	21
8.4.1	Analog output.....	21
8.4.2	Counter setting.....	22
8.4.3	Alarm settings.....	23
8.4.4	Modbus settings.....	24
8.4.5	Sensor Info.....	24
9	LED indicators at the front panel.....	25
10	Signal outputs.....	26
10.1	Analog output	26
10.2	Digital output	26
10.3	Alarm output	28
11	Optional accessories.....	29
12	Calibration.....	30
13	Maintenance.....	30
14	Disposal or waste.....	31
15	Warranty.....	31

1 Safety instructions

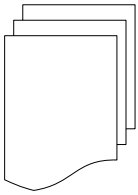

Please check if this instruction manual matches the product type.

Please observe all notes and instructions indicated in this manual. This manual contains essential information that must be observed before and during installation, operation and maintenance. Therefore this manual must be read carefully by the technician as well as by the responsible user or qualified personnel.

This instruction manual must be available at the operation site of the product at any time. In case of any obscurities or questions regarding this manual or the product, please contact the manufacturer.

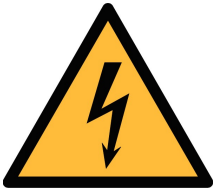

WARNING!

Compressed air!

Any contact with quickly escaping air or bursting parts of the compressed air system can lead to serious injuries or even death!

- Do not exceed the maximum permitted pressure range (see sensors label).
- Use only pressure-tight installation material.
- Prevent persons from being hit by escaping air or bursting parts of the instrument.
- The system must be pressureless during maintenance work.



WARNING!

Voltage used for supply!

Any contact with energized parts of the device may lead to an electrical shock which can lead to serious injuries or even death!

- Consider all regulations for electrical installations.
- The system must be disconnected from any power supply during maintenance.
- Any electrical work on system is allowed only by authorized qualified personal.



ATTENTION!

Permitted operating parameters!

Observe the permitted operating parameters. Any operation beyond these parameters can lead to malfunctions and may lead to damage on the product or the system.

- Do not exceed the permitted operating parameters.
- Make sure that the product is operated under its permitted conditions.
- Store and operate the product at the permitted temperature and pressure.
- The product should be maintained and calibrated frequently, at least annually.

General safety instructions

- It is not allowed to use the product in explosive areas.
- Please observe the national regulations before and during installation and operation.

Remark

It is not allowed to disassemble the product.



ATTENTION!

Measurement values can be affected by malfunction!

The product must be installed properly and maintained frequently. Otherwise it may lead to wrong measurement values, which can lead to wrong results.

Storage and transportation

- Make sure that the transportation temperature for the product without display is between $-30 \dots +70^{\circ}\text{C}$ and for the product with display between $-10 \dots +60^{\circ}\text{C}$.
- It is recommended to use the packaging that comes with the product for storage and transportation.
- Make sure that the storage temperature of the product is between $-10 \dots +50^{\circ}\text{C}$.
- Avoid direct UV and solar radiation during storage.
- The storage humidity must be $< 90\%$ with no condensation.



ATTENTION!

Equipment may get damaged!

Please make sure, that your measuring point is free of excessive contamination and dirt. This should be maintained before every measurement.

- Observe the measuring point always before measurement if it is free of contamination like water drops, oil drops or other rough contamination.
- Should water hit the inner electronics, the sensors could be seriously damaged.
- Before you start to measure, check your measurement point by using a simple filter to see if any rough contamination is present. (Example of such a test device is shown below. Ask the supplier if not sure.)

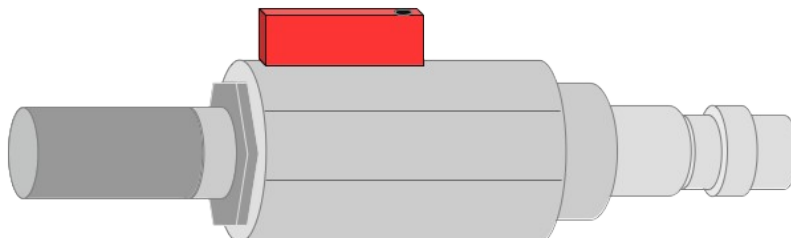

2 Application

The S132 is a laser particle counter, which is designed to measure particles in compressed air or compressed gases. For the permissible operating parameters, see chapter [4 Technical data](#).

The measurement result can be the number of particles per ft³ or m³. You can choose the unit setting, as needed, using the optional integrated display, an external display, or the service kit.

The S132 laser particle counter is mainly used in compressed air systems in industrial environments, and is not designed for use in explosive areas. To use it in explosive areas, please contact the manufacturer.

3 Features

- Measures particle content in compressed air or compressed gases.
- Easy connection through sampling hose and quick connector.
- Applicable to stationary or portable applications.
- Measures particles larger than 0.1 µm.
- Compliance with ISO 8573-4.
- Service indication through LED.
- Connectable to display and data logger produced by the manufacturer and by third-party manufacturers.
- IP65 casing provides robust protection in rough industrial environments.
- Optional integrated display for monitoring and configuration.

4 Technical data

4.1 General data

CE	
Parameters	Particle counts per ft ³ or m ³
Principle of measurement	Laser detection
Sensor	LED-laser
Measured medium	Compressed air
Measuring channels	CH1: $0.1 < d \leq 0.5 \mu\text{m}$ CH2: $0.5 < d \leq 1.0 \mu\text{m}$ CH3: $1.0 < d \leq 5.0 \mu\text{m}$ CH4: $5.0 \mu\text{m} < d$ (configurable)
Flow rate	2.83 l/min
Sample rate	1 minute sampling time (Values are updated every one minute.)
Ambient temperature	+10 ... +40°C
Humidity of the measured medium	< 40% rH, no condensation
Operating pressure	0.3 ... 1.0 MPa
Housing material	PC, Al alloy
Protection class	IP65
Dimensions	See the dimensional drawing on page 10.
Display (optional)	5" graphic display, 800 x 480 pixels with touch interface
Weight	1.9 kg

4.2 Electrical data

Power supply	24 VDC, 10 W without display 24 VDC, 20 W with display
--------------	---

4.3 Output signals

Analogue output	4 ... 20 mA
Digital output	RS-485, Modbus/RTU
Alarm output	NO, 32 VDC, 200 mA

4.4 Counting efficiency

Counting efficiency per JIS	50% for smallest size and 100% for particles 1.5 times bigger
-----------------------------	---

4.5 Procedure of general particle counting

1. The S132 does not count any particles in the first five minutes. During this period, it performs a purge process to ensure that any remaining particles in the system are blown out.
2. After purging, the S132 starts sampling at a sampling interval of 1 minute.
 - a. In the next 30 minutes, S132 classifies the sampled values based on particle sizes and then accumulates them.
 - b. After the 30 minutes, every one minute (sampling interval), S132 removes the earliest sample values from the accumulated values, and then add the latest sampled value into the accumulated values to obtain the accumulated particle values within the last 30 minutes.

5 Dimensional drawing

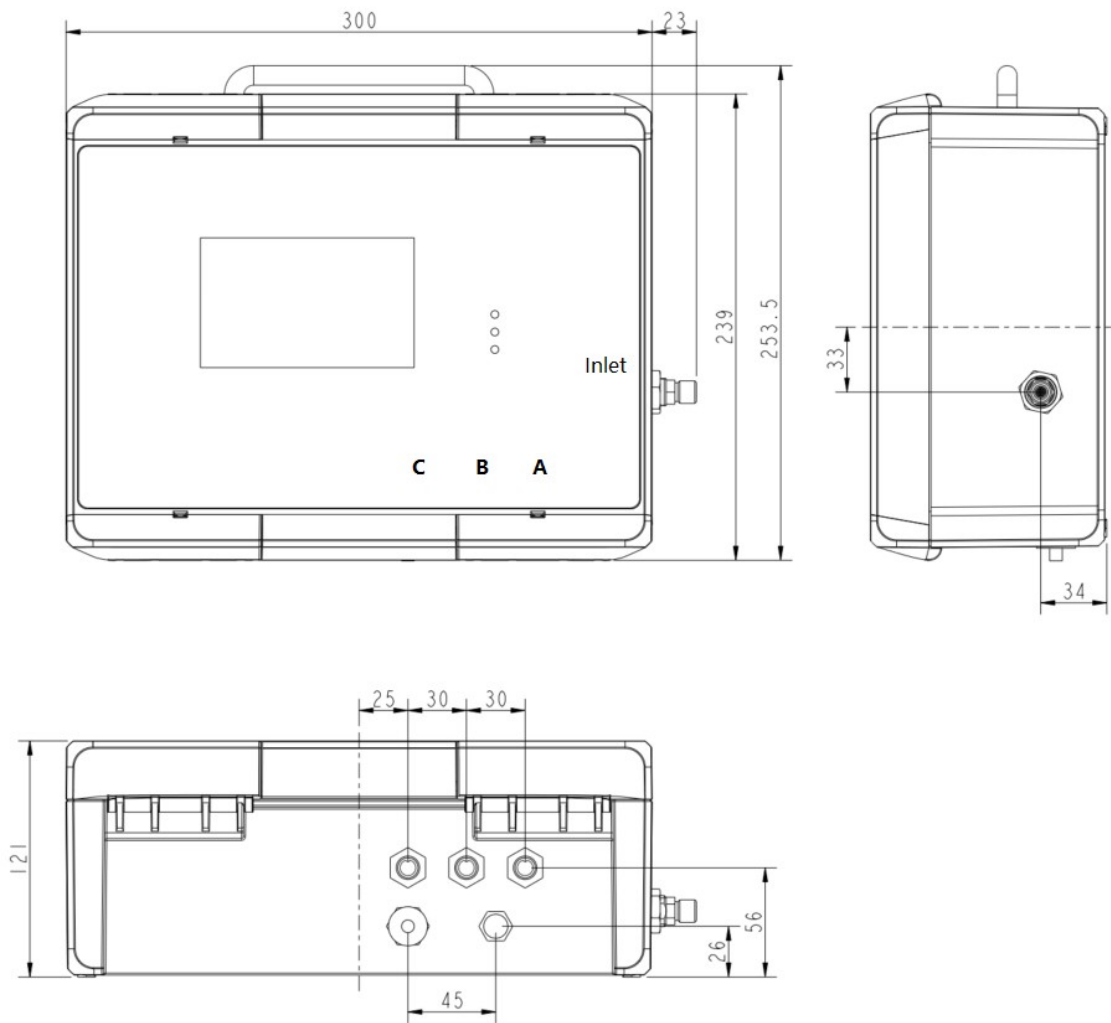

6 Installation

Please make sure that all components listed below are included in your package.

Qty	Description	Item No.
1	S132 laser particle counter	S604 1308/ S604 1309

Note: S604 1309 has an integrated display and data logger while S604 1308 does not.

3	M12 connectors	C219 0059
1	1.5 m teflon hose with a quick connector	A554 0003
1	Mounting brackets	No P/N
1	Instruction manual	No P/N
1	Calibration certificate	No P/N

6.1 Installation requirements

S132 can be used as a stationary or portable instrument.

S132 comes with four mounting brackets. In the stationary installation, mount the brackets from the backside of the instrument at each corner. The brackets enable you to install the instrument on the wall easily. The following are dimensional drawings of two installing methods.

Method 1

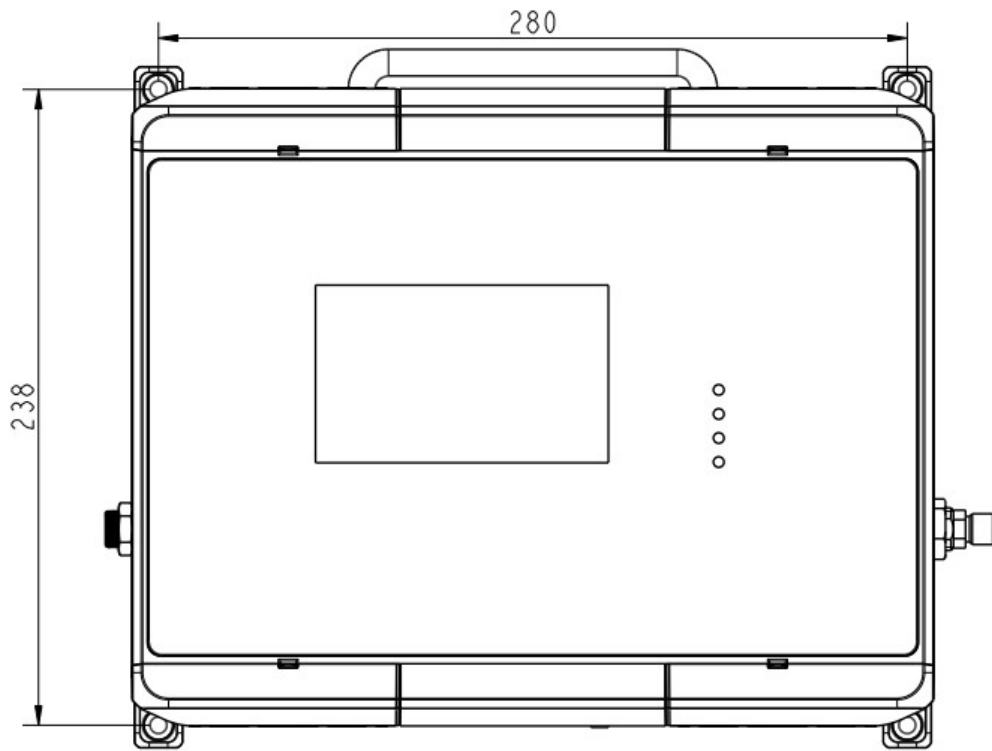

Method 2

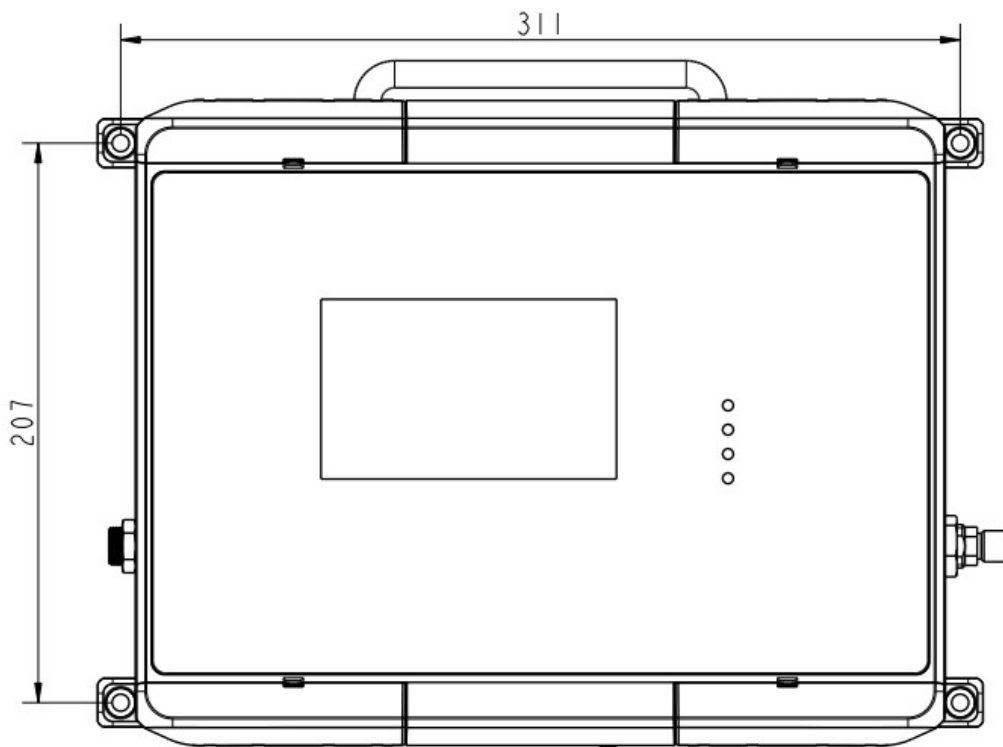

6.2 Installation procedure

The following steps explain the procedure of an appropriate installation.



1. Connect the teflon hose with the inlet of the S132 as shown in the left figure.



2. Connect the quick connector on the other end of the teflon hose with the process.

Please consider the following recommendations for a successful measurement result:

- All components from the sampling point to the S132 must be oil and grease free.
- Ambient and gas temperature must be within the specified ranges.
- The inlet gas must be pressurized with the valid ranges.
- The sampling gas must be dry (< 40% rH) and clean.
- Ensure that valves at the sampling point are not lubricated.



ATTENTION!

Avoid contamination with oil or grease!

It will lead to very slow measurement or impossible measurement results!

6.3 Electrical connection

The S132 comes with three M12 connectors "A", "B" and "C".

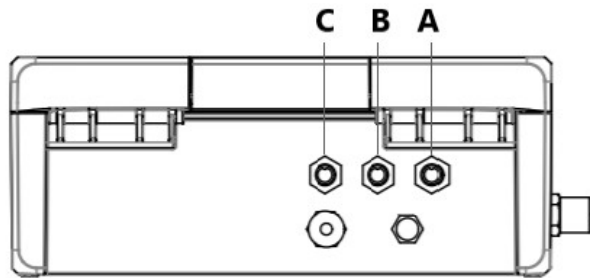

Pin assignment

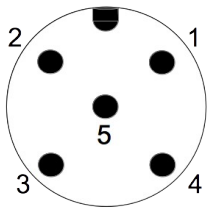

Front view

Connector	Pin 1	Pin 2	Pin 3	Pin 4	Pin 5
A	SDI	-V _b	+V _b	+D	-D
B	PE	-V _b	+V _b	+I	-I
C	Relay	Relay	GND	+D	-D
	brown	white	blue	black	grey

Legend:

- SDI Digital signal (internal use)
- V_B Negative supply voltage
- +V_B Positive supply voltage
- +I Positive 4 ... 20 mA signal
- I Negative 4 ... 20 mA signal
- +D RS-485, Modbus / RTU
- D RS-485, Modbus / RTU
- Relay Alarm output
- PE Protective Earth
- GND Communication ground

Connection to the following external display units

S132		Colour code	S330/S331		S320	
Pin	Signal		Terminal	Pin	Terminal	Pin
A.1	SDI	brown	A	1	G	6
A.2 / B.2	-V _b	white		2		7
A.3 / B.3	+V _b	blue		3		8
A.4 / C.4	+D	black		4		
A.5 / C.5	-D	grey		5		
B.1	PE	brown		GND		
A.1	SDI	brown	B	1		
A.2 / B.2	-V _b	white		2		
A.3 / B.3	+V _b	blue		3		
A.4 / C.4	+D	black		4		
A.5 / C.5	-D	grey		5		
B.1	PE	brown			GND	

7 Configuration

The S132 is delivered with standard factory settings (as shown below) or specific customer settings according to the order.

Scaling : 4 mA = 0
 20 mA = 100000 cn/m³

Alarm : NO, 32 VDC / 200 mA

Modbus : Device address = 1
 Baudrate = 19200
 Framing/parity/Stop bit = 8, N, 1
 Transmission mode = RTU

You can change the settings using the following devices.

7.1 Integrated display

If the S132 comes with a display (Item No: S604 1309), you can configure the settings directly using the display. For more information, see chapter [8 Operation using the integrated display](#).

7.2 Service kit

If the S132 does not come with a display (Item No: S604 1308), you can configure the S132 using the optional service kit.

For more information, please see chapter [11 Optional accessories](#).

7.3 External display

If you have the S330/S331 display available, you can connect the S132 with S330/S331 via SDI, and change the settings using this display. Please see the instruction manual of the S330/S331 for details.

8 Operation using the integrated display

If the S132 comes with a display (Item No: S604 1309), you can view particle counts in real-time and configure the S132 using the display.

8.1 Value view

After the S132 is powered on and initialized, the screen displays the value view as shown below.

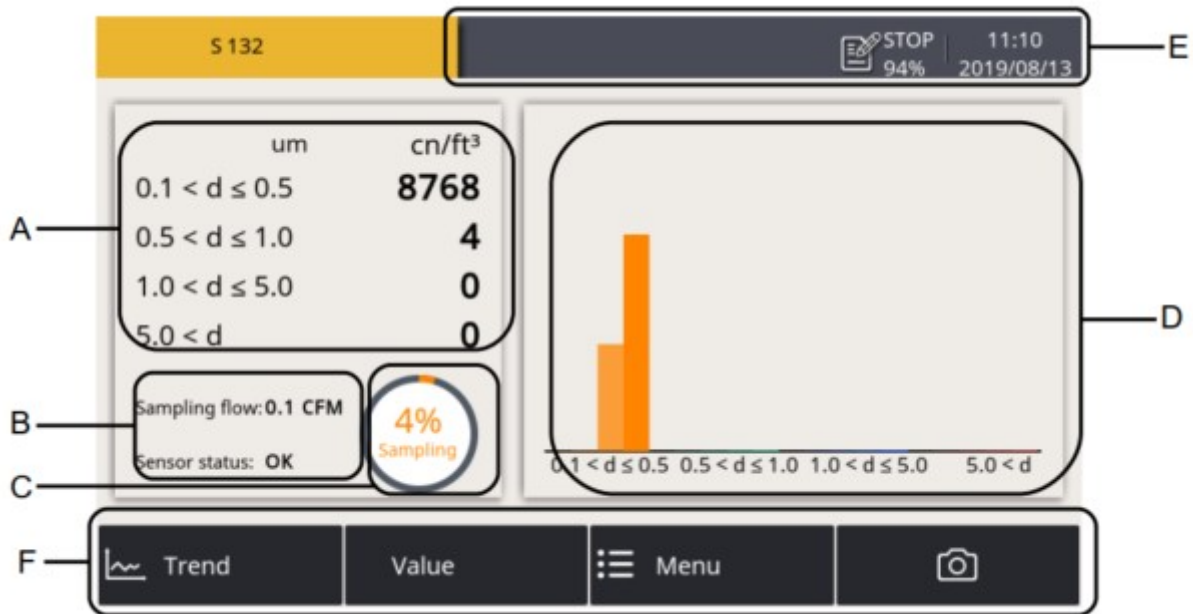

Area	Description
A	Shows the actual sampling result in all sizing channels.
B	Shows the sampling status as follows: <ul style="list-style-type: none"> • Sampling flow (0.1 CFM = 2.83 l/min) • Sensor status: <ul style="list-style-type: none"> ○ OK: Indicates that everything is normal. ○ Service: Indicates that this instrument needs to be serviced and you should contact the customer service. NOTE: "Service" may also be shown if the air is supplied with high concentration of particles or the supply pressure is below the required minimum pressure. In such cases, make sure that you operate in the specified pressure range and purge the sample air through the device for about ten minutes. If "service" is still displayed, please contact the customer service.

Area	Description
C	Shows the progress of the sampling or purging process. The S132 purges sampled data in the first five minutes after powered on. During this period, the progress of "Purging" instead of "Sampling" is displayed.
D	Shows the last four particle counts of each channel in a bar graph.
E	Status bar, shows the S132 running status. For more information, see 8.1.1 Icons in the status bar .
F	Quick buttons and icon: <ul style="list-style-type: none"> • Trend: Click to switch to the graphic view where the four channels and their particle counts over a period of time are displayed in a line graph. • Value: Click to switch to the value view where the four channels and their particle counts are displayed in real time. • Menu: Click to switch to the main menu. For more information, see 8.3 Menu. • The camera icon: Click to capture the current screen. You can read out these screenshots through the USB port.

8.1.1 Icons in the status bar

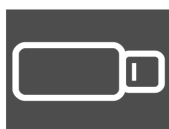

USB stick connected



System error



Sensor connection has changed, not matching with configuration



Sensor unit is not matching with configuration



Logger version

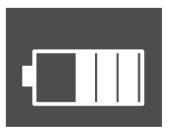

RTC backup battery status



Sensor calibration is expired

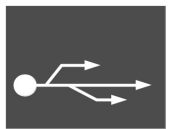

USB to PC connected



Alarm triggered

8.2 Trend view

Shows the dynamic graphs of all measurements. To view the trend screen, press **Trend** in the bottom bar.

The trend view is pre-configured in the factory. You can view the S132 measurement graph without configuring anything. In case that you want to manipulate the graph, follow the instructions indicated in the following figure.

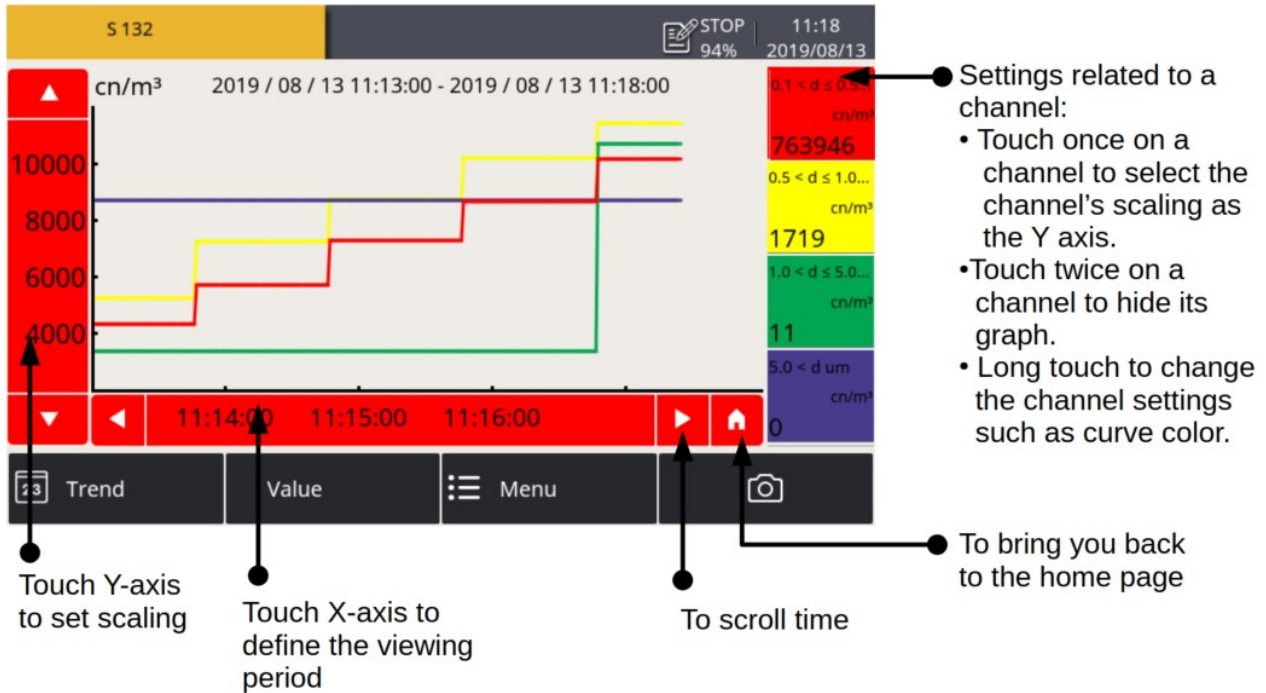

8.3 Menu

Enables you to change the S132 settings.

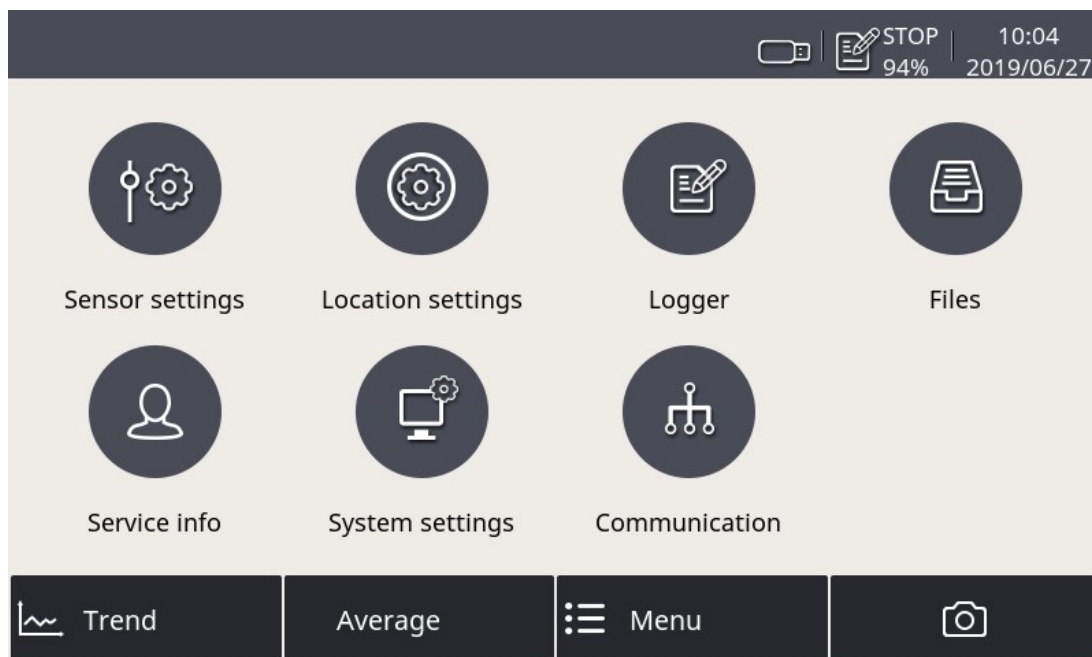

The menu consists of the following function buttons:

Sensor settings	To change the S132 sensor settings
Location settings	To customize the sensor name shown on the top left of the screen
Logger	To change data logger settings
Files	To manage all recorded files and to check the memory status
Service info	To view contact information of the service provider
System settings	To change other system-level settings such as the language setting
Communication	To configure Modbus master and field bus RS-485 related settings

8.4 Sensor settings

As stated in Chapter 7, the S132 is delivered with standard ex-factory configuration or with specific customer settings according to the order.

Before starting to measure, you can access sensor settings using the Menu > Sensor settings menu to view the sensor settings; and If needed, you can change these settings.

After making any changes to the settings, please remember to click the Save button.

8.4.1 Analog output

To change the ex-factory settings for the analog output. S132 provides only one analog output, which means only one measuring channel can be output using the 4 ... 20 mA signal.

The screenshot shows the 'Sensor settings' menu with a green header. The 'Analog output' option is selected in the left sidebar. The main content area is titled 'Analog output' and contains the following settings:

- Channel:** A dropdown menu showing '0.1 < d ≤ 0.5 (cn/ft³)' with a green ellipsis button to its right.
- 4 mA =** A text input field containing the value '0' followed by the unit 'cn/ft³'.
- 20 mA =** A text input field containing the value '1000000' followed by the unit 'cn/ft³'.

A green 'Save' button is located at the bottom right of the settings area.

- Channel** To select the channel that the S132 provides the analog output for
- 4 mA** To enter the particle count that 4 mA is scaled to
- 20 mA** To enter the particle count that 20 mA is scaled to

8.4.2 Counter setting

To change the ex-factory counter settings.

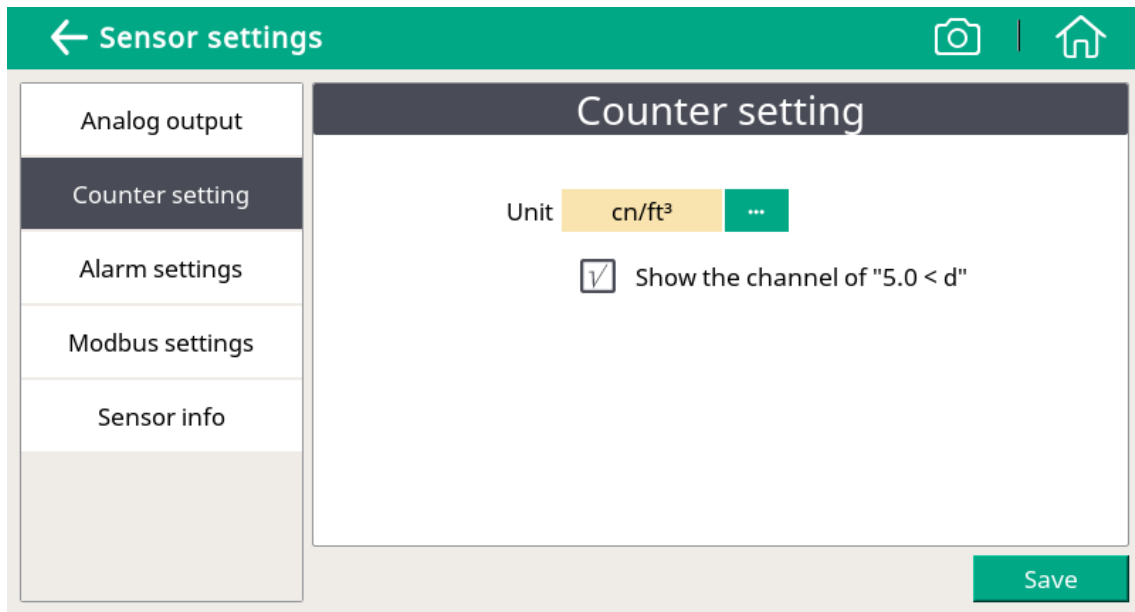
**Unit**

To select the unit of the counter

Show the channel of "5.0<d"

To show or hide the "5.0<d" channel on the screen

8.4.3 Alarm settings

S132 provides one alarm relay output through the pin 1 and 2 of connector C (NO, 32 VDC / 200 mA). You can use this output to trigger an external alarm device.

The Alarm settings menu enables S132 to trigger the alarm output based on particle counts in a specified channel.

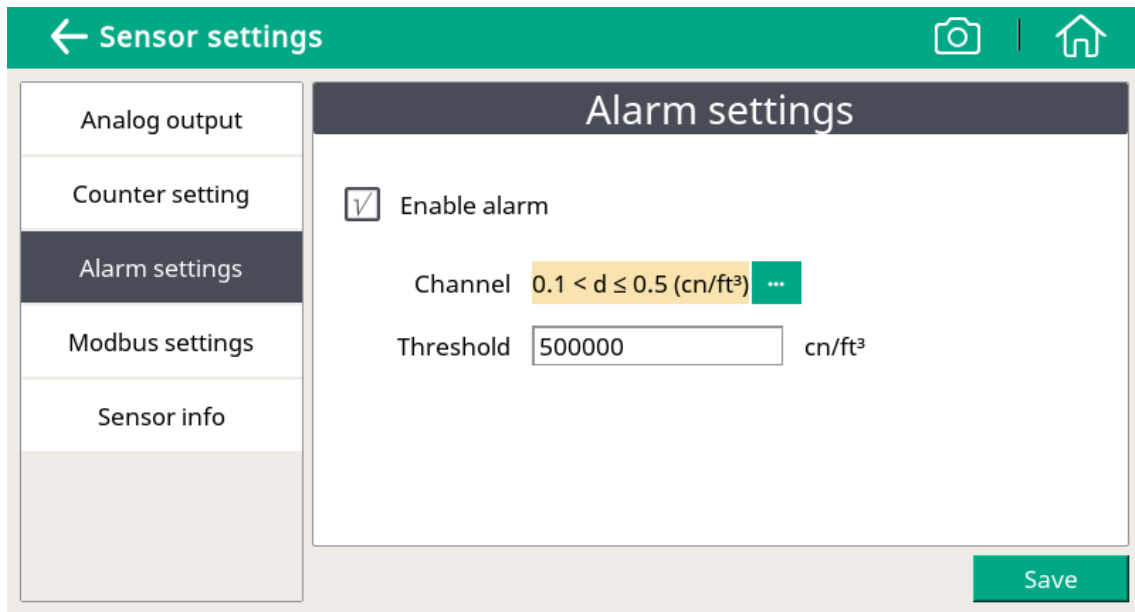

Enable alarm To enable or disable the alarm output.

Channel To select a channel that is monitored to trigger the alarm output.

Threshold To enter the alarm threshold for the monitored channel.

8.4.4 Modbus settings

To change the ex-factory Modbus settings.

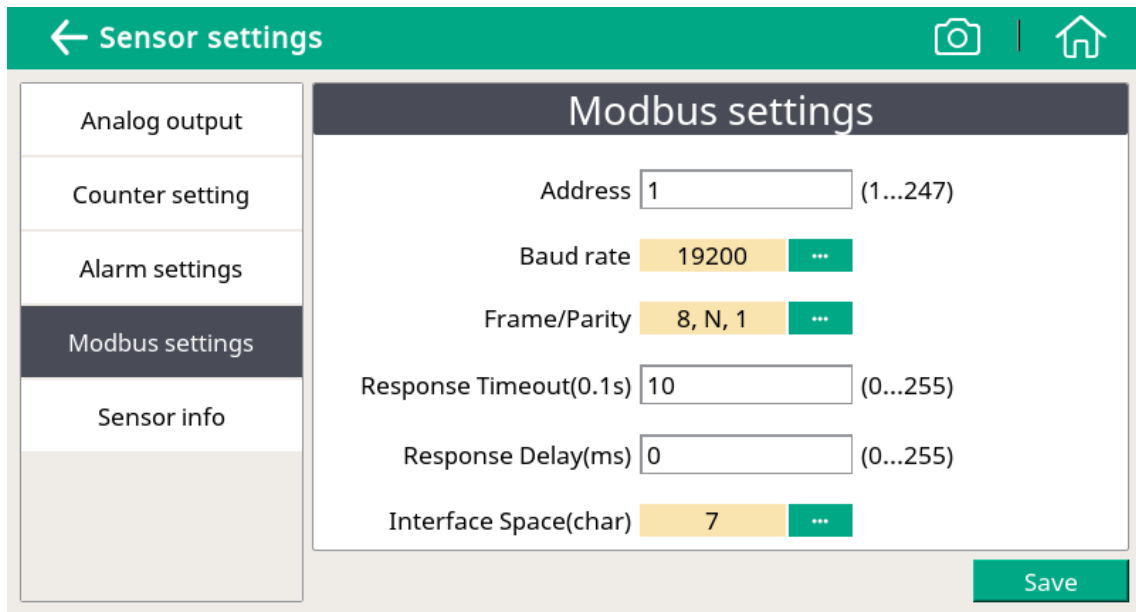

8.4.5 Sensor Info

To view the sensor information including the type, serial number, and firmware version.

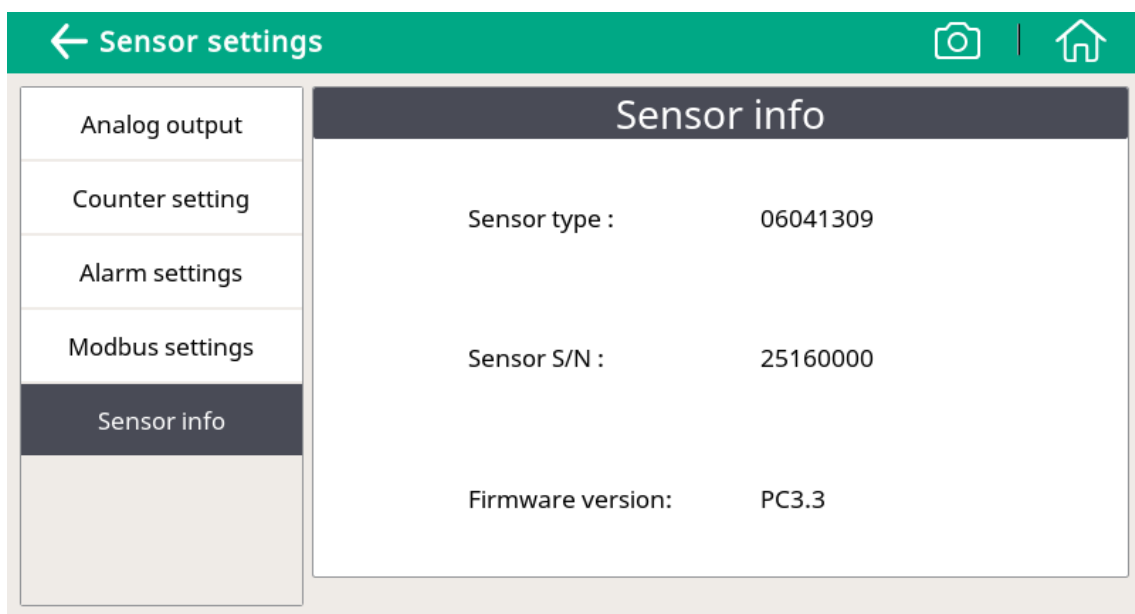

9 LED indicators at the front panel

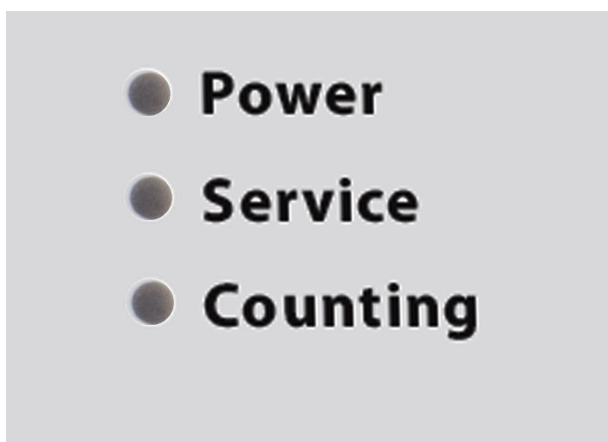

- Power LED on—Indicates power supply is connected well.
- Service LED on*—Indicates the device needs to be serviced.
- Counting LED on—Indicates the device is counting particle.

* **NOTE:** The Service indicator may also be turned on if the air is supplied with high concentration of particles or the supply pressure is below the required minimum pressure. In such cases, make sure that you operate in the specified pressure range and purge the sample air through the device for about ten minutes. If the service indicator is still on, please contact the customer service.

10 Signal outputs

10.1 Analog output

The S132 has an analog output range of 4 ... 20 mA. This output is scaled to:

- 4 mA = 0
- 20 mA = 100000 cn/m^3

10.2 Digital output

Modbus operation

Index	Channel description		Unit	Res.	Format	Access	Modbus address
0	Device status			1	UNIT32	R	6
1	Count channel	Channel 1	cn/m^3	1	FLOAT	R	8
2		Channel 2	cn/m^3	1	FLOAT	R	10
3		Channel 3	cn/m^3	1	FLOAT	R	12
4		Channel 4	cn/m^3	1	FLOAT	R	14
5	Original channel	Channel 1	$\text{cn}/2.83 \text{ l}$	1	UNIT32	R	80
6		Channel 2		1	UNIT32	R	82
7		Channel 3		1	UNIT32	R	84
8		Channel 4		1	UNIT32	R	86
9	Size of channel 1				ASCII string*	R	100
10	Size of channel 2				ASCII string*	R	102
11	Size of channel 3				ASCII string*	R	104
12	Size of channel 4				ASCII string*	R	106
13	Unit of counting channel				ASCII string*	R	110
14	Unit of original channel				$\text{cn}/2.83 \text{ l}$	R	118

Index	Channel description	Unit	Res.	Format	Access	Modbus address
15	Analog output scaling, 4mA			Float	R	124
16	Analog output scaling, 20 mA			Float	R	126
17	Analog output routing		1	UNIT16	R	128
18	Alarm threshold			Float	R	130
19	Alarm routing		1	UNIT16	R	132

* The size of channel and the unit of channel is depending on the model (for example, size: "0.1", "0.5"... , unit: "cn/m³", "cn/l"...). If the channel is not available in the model, the string is null.

Interpretation of system status

Bit Description

- 0 Laser alert status:
0 = laser is good, 1 = laser alert
- 1 Flow alert status:
0 = flow rate is good, 1 = flow rate alert
- 2 Particle overflow status:
0 = no overflow, 1 = instrument malfunction detected
- 3 Instrument service status:
0 = working correctly. 1 = threshold exceeded
- 4 Particle threshold exceeded status:
0 = threshold not exceeded, 1 = threshold exceeded
- 5 Alarm status
0 = normal, 1 alarm triggered

10.3 Alarm output

The sensor has a relay output with a NO, 32 VDC / 200 mA rating. It is possible to monitor, for example the particle content and give an alarm at a particular value.

Alarm relay specifications:

Rating: 32 VDC / 200 mA
 Power off state: NO (normally open)
 Default threshold value: 500000 cn/m³

Please find the different states in the following table below.

Situation	Relay state
S132 is powered off	OPEN
S132 is powered on / The alarm value is not reached	CLOSED
S132 is powered on / The alarm value is reached	OPEN

The advantage of the normally open relay is, that both critical situations can be detected, not only if the alarm value is reached, also if the device has any power loss.

To trigger an external buzzer or alarm light, you need to invert the signal and build an external alarm circuit. The following figure shows an example.

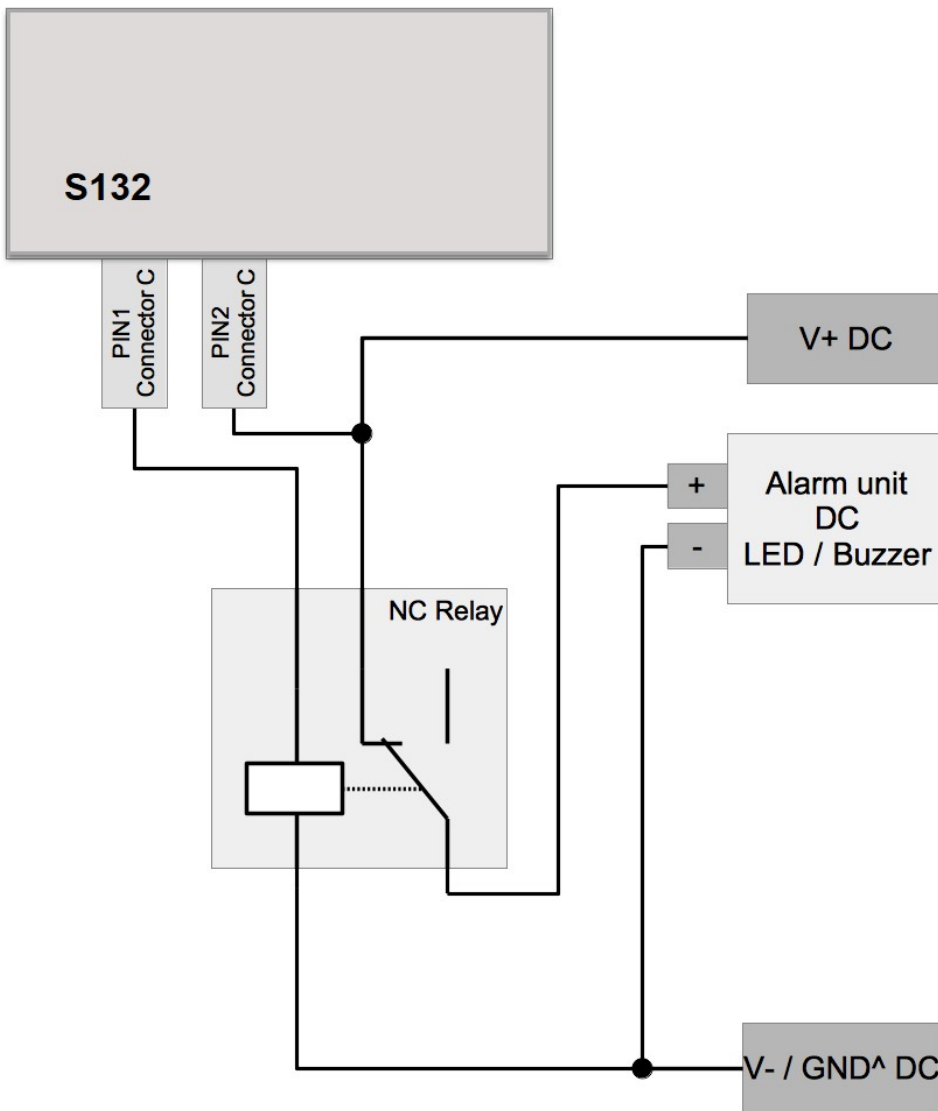

11 Optional accessories

Service kit is an optional tool that enables you to manage and monitor SUTO devices on a computer.

The following figure shows the connection of the service kit, S132, and the computer. Please ensure that either the S132 or the service kit is connected with the power supply because the USB port cannot supply enough power to both these two devices.

Please see the instruction manual of the service kit for more details.

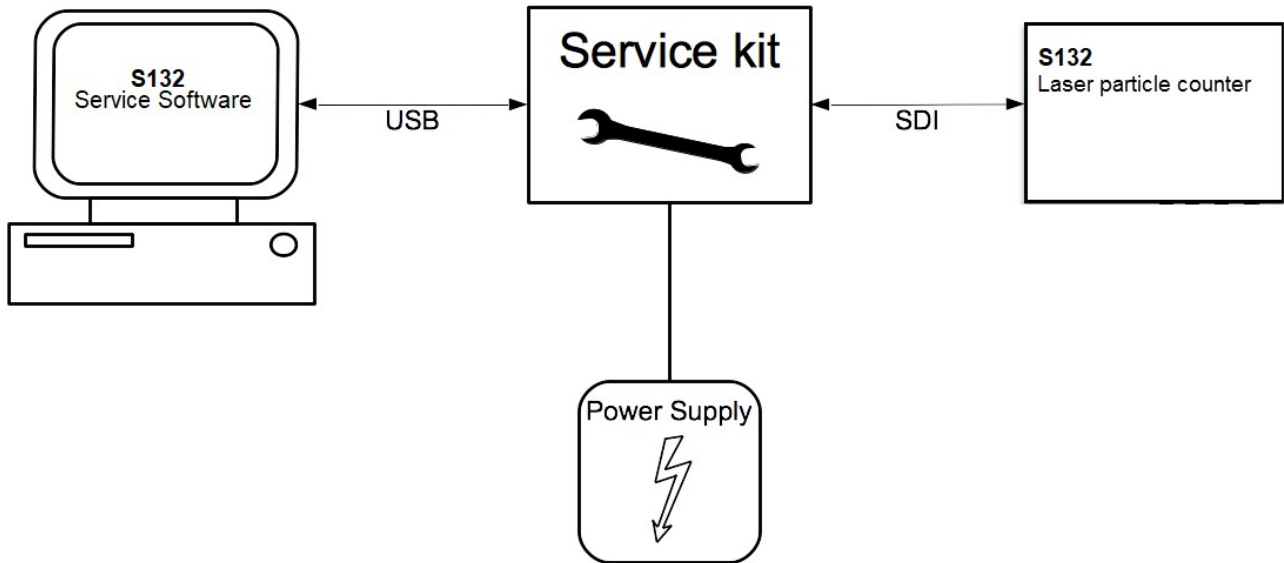

12 Calibration

The sensor is calibrated before delivery. The exact calibration date is printed on the certificate which is supplied together with the sensor. The accuracy of the sensor is regulated by the on-site conditions, and parameters such as oil, high humidity or other impurities can affect the calibration and furthermore the accuracy. However we recommend you calibrate the instrument at least once per year. The calibration is excluded from the instruments warranty. To inquiry with the calibration service, please contact the manufacturer.

13 Maintenance

To clean the device and its accessories, it is recommended to use moist cloth only.



ATTENTION!

Do not use isopropyl alcohol to clean the display!

14 Disposal or waste



Electronic devices are recyclable material and do not belong in the household waste.

The sensor, the accessories and its packings must be disposed according to your local statutory requirements.

The dispose can also be carried by the manufacturer of the product, for this please contact the manufacturer.

15 Warranty

SUTO provides a warranty for this product of 24 months covering the material and workmanship under the stated operating conditions from the date of delivery. Please report any findings immediately and within the warranty time. If faults occur during the warranty time, SUTO will repair or replace the defective unit, without charge for labour and material costs but there is a charge for other service such as transport and packing costs.

Excluded from this warranty is damage caused by any of the following actions:

- Improper use and non-adherence to the instruction manual.
- Use of unsuitable accessories.
- External influences (e.g. damage caused by vibration, damage during transportation, excess heat or moisture).

The warranty is void if any of the following occurs:

- Users open the measurement instrument without a direct request written in this instruction manual.
- Repairs or modifications are undertaken by third parties or unauthorised persons.
- The serial number has been changed, damaged or removed.

Other claims, especially those for damage occurring outside the instrument are not included unless responsibility is legally binding.

Warranty repairs do not extend the period of warranty.



ATTENTION!

Batteries have a reduced warranty time of 12 months.