

# Instruction and operation manual

# S461

## Ultrasonic flow meter



Dear Customer,

Thank you for choosing our product.

Before you start up the device please read this manual in full and carefully observe instructions stated in this manual. The manufacturer cannot be held liable for any damage that occurs as a result of non-observance or non-compliance with this manual.

Should the device be tampered with in any manner other than a procedure that is described and specified in the manual, the warranty is void and the manufacturer is exempt from liability.

The device is destined exclusively for the described application.

SUTO offers no guarantee for the suitability for any other purpose. SUTO is also not liable for consequential damage resulting from the delivery, capability or use of this device.

## Table of Contents

1	Safety instructions.....	5
2	Registered trademarks.....	7
3	Applications.....	8
4	Features .....	9
5	Technical Data.....	10
5.1	Measurement.....	10
5.2	Signal and Interface.....	11
5.3	General data.....	11
5.4	Operating conditions.....	12
5.5	Flow range.....	13
6	Determination of installation point.....	14
7	Installation.....	16
7.1	Installing S461 main unit.....	18
7.2	Electrical connection.....	19
7.2.1	M12 connection pins.....	19
7.2.2	Ethernet connection.....	21
7.2.3	M8 connection pins.....	23
7.3	Setting S461 by S4C-US App.....	24
7.3.1	Installing S4C-US App .....	24
7.3.2	Scanning QR code .....	24
7.3.3	Basic Settings.....	25
7.3.4	Installation settings.....	27
7.4	Transducer Installation .....	28
7.4.1	Installing and removing the transducers.....	28
7.4.2	Removing a transducer.....	29
7.5	Final check.....	30
7.6	Other Issues and recommended actions.....	32
8	Other settings.....	32
8.1	Factory settings.....	32
8.1.1	Fixed delay.....	32
8.1.2	User calibration factor.....	32
8.1.3	Cut-Off velocity.....	32
8.1.4	Bi-directional flow.....	33
8.1.5	Delta T Cut-Off.....	33
8.2	Totalizer settings.....	33
8.3	Alarm settings.....	33
8.4	Output settings.....	33
8.4.1	Modbus output.....	33
8.4.2	Analog output .....	34
8.4.3	Pulse output.....	34
8.4.4	Alarm output.....	35

---

8.5 Calibration.....	36
8.5.1 Zero flow calibration.....	36
8.5.2 T-Offset calibration.....	36
8.5.3 User calibration.....	36
8.6 Logger settings.....	36
9 System Functions.....	37
9.1 Sensor info.....	37
9.2 Language.....	37
9.3 Logger status.....	37
9.4 System log.....	37
9.5 Wireless sensor connection .....	37
9.6 App version.....	37
10 Calibration.....	38
11 Maintenance.....	38
12 Disposal or waste.....	38
13 Appendix – Modbus register table.....	39

## 1 Safety instructions

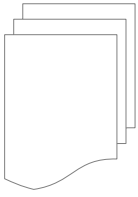

**Please check if this instruction manual matches with the product type.**

Please observe all notes and instructions indicated in this manual. This manual contains essential information that must be observed before and during installation, operation and maintenance. Therefore this manual must be read carefully by the technician as well as by the responsible user or qualified personnel.

This instruction manual must be available at the operation site of the product at any time. In case of any obscurities or questions regarding this manual or the product, please contact the manufacturer.

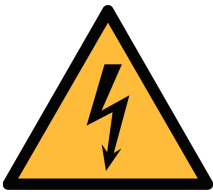

### **WARNING!**

#### **Voltage used for supply!**

**Any contact with energized parts of the product, may lead to a electrical shock which can lead to serious injuries or even death!**

- Consider all regulations for electrical installations.
- The system must be disconnected from any power supply during maintenance work.
- Any electrical work on the system is only allowed by authorized qualified personal.



### **ATTENTION!**

#### **Permitted operating parameters!**

**Observe the permitted operating parameters, any operation exceeding this parameters can lead to malfunctions and may lead to damage on the instrument or the system.**

- Do not exceed the permitted operating parameters.
- Make sure the product is operated in its permitted limitations. Store and operate the product at the permitted temperature and pressure.
- The product must be maintained and calibrated frequently, at least annually.

## General safety instructions

- It is not allowed to use the product in explosive areas.
- Please observe the national regulations before/during installation and operation.

## Remarks

- It is not allowed to disassemble the product.
- Always use spanner to mount the product properly.



### **ATTENTION!**

**Measurement values can be affected by malfunction!**

**The product must be installed properly and frequently maintained, otherwise it may lead to wrong measurement values, which can lead to wrong results.**

- Do not exceed the maximum operation temperature of the transducer.

## Storage and transportation

- Make sure that the transportation temperature of the device is between  $-30 \dots +70^{\circ}\text{C}$ .
- For transportation it is recommended to use the packaging which comes with the device.
- Please make sure that the storage temperature of the device is between  $-10 \dots +50^{\circ}\text{C}$ .
- Avoid direct UV and solar radiation during storage.
- For the storage the humidity must be  $<90\%$  with no condensation.

## 2 Registered trademarks

<b>Trademark</b>	<b>Trademark owner</b>
SUTO®	SUTO ITEC
MODBUS®	Modbus Organization, Hopkinton, USA
HART®	HART Communication Foundation, Austin, USA
Android™, Google Play	Google LLC

### 3 Applications

The SUTO ultrasonic clamp-on flow meter S461 has all it takes to measure reliable, easy and accurate flow and consumption of liquids. Based on the transit time technology this flow meter comes with unique features and outstanding performance.

The sensors are simply clamped onto the outside of the pipe and never come in contact with the fluid. The main unit can be installed onto the pipe, at the wall or onto a DIN rail.

The configuration and setup is made through the wireless smartphone app S4C-US, which can be downloaded for free from the SUTO website, Google Play Store and the Apple App Store.

The app allows the user to set up the device as well as reading live values, logger configuration and logger data read out.

By adding 2 clamp-on temperature sensors the Energy Meter Version monitors the efficiency of heat exchangers.

The S461 comes also as portable version in a transport case.

The liquids that S461 can measure include the following:

- Acetone
- Alcohol
- Benzol
- N-Butane
- Butanol
- Kerosene
- Oil, Castor
- Oil, Diesel
- Oil, Fuel
- Water, distilled
- Water, Sea
- Others (please enter sonic speed)

The S461 flow meter is mainly used in an industrial environment. It is not developed to be used in explosive areas.



## 4 Features

- Uses the proven clamp-on transit-time correlation technique.
- Easy to install for permanent and temporary installations.
- User friendly configuration through the dedicated smartphone App.
- A wide range of pipe sizes from DN40 to DN1200.
- Data analysis via the S4A software.
- Through additional temperature sensor inputs S461 can be used as energy meter to monitor heat exchanger.
- Bi-directional flow measurement.
- Measurement log files can be downloaded through mobile App, via USB OTG or by using the free S4A Software.

## 5 Technical Data

### 5.1 Measurement

<b>CE</b>	
<b>Flow</b>	
Accuracy	1.0% o. RDG $\pm 0.01$ m/s
Selectable units	Metric: m/s, m <sup>3</sup> /h, m <sup>3</sup> /min, l/min, m <sup>3</sup> Imperial: ft/min, cfm, cfs, USG/min, IG/min, bbl/min
Measuring range	0 ... 12 m/s
Repeatability	0.2% of reading
Sensor	Ultrasonic sensor
Sampling rate	5 samples / sec
Turndown ratio	50:1
Response time (t <sub>90</sub> )	0.1 sec
<b>Consumption</b>	
Selectable units	Metric: m <sup>3</sup> , l Imperial: cf, IG, UG, bbl
<b>Temperature</b>	
Accuracy	0.5 °K
Selectable units	Metric: °C, Imperial: °F
Measuring range	-40 ... +130 °C
Sensor	Pt1000
<b>Energy Flow</b>	
Selectable units	Metric: GJ/h, kJ/h, kcal/h Imperial: MBtu/h, Btu/h
<b>Energy</b>	
Selectable units	Metric: GJ, kJ, kcal, kWh, MWh Imperial: MBtu, Btu

## 5.2 Signal and Interface

<b>Analog output (Optional)</b>	
Signal	4 ... 20 mA (4-wire), isolated
Scaling	0 ... max flow, freely adjustable
Load	max. 250 Ohm
Update rate	300 msec
<b>Pulse output (Optional)</b>	
Signal	Switch output, normally open, max. 30 VDC, 20 mA
Scaling	1 pulse per consumption unit (selectable)
<b>Fieldbus</b>	
Protocol	Modbus/RTU (Standard) Modbus/TCP and PoE (Optional)
<b>Supply</b>	
Voltage supply	20 ... 28 VDC
Current consumption	150 mA @ 24 VDC

## 5.3 General data

<b>Configuration</b>	
Wireless	S4C-US App for mobile phones
<b>Display</b>	
Size/resolution	2.4" color (640 x 480) graphic display, 1 touch button
<b>Data Logger</b>	
Storage	8 Mio. values
<b>Material</b>	
Main Casing	PC + ABS
Sensor	UT-S: Industrial synthetic plastics UTH-S: Aluminum
<b>Miscellaneous</b>	
Electrical connection	2 x M12 (4-pole): transducer 1 x M12 (5-pole): Signals/Supply 1 x M12: 5-pole for Analog/Pulse (standard),

	or 8-pole x-coded for Modbus/TCP 2 x M8 (4-pole): Pt1000 (Energy Meter Version)
Protection class	Main casing: IP65. Sensors: IP68
Approvals	CE, RoHS, FCC
Weight	1.2 kg
Dimensions	Main unit: 124 x 102 x 70 mm UT-S sensor: 64 x 30 x 27 mm UTH-S sensor: 68 x 34 x 34 mm

#### 5.4 Operating conditions

Fluids	All acoustically conductive liquids with less than 10 % gaseous
Medium temperature	-40 ... +130 °C
Ambient temperature	Main unit: 0... +50 °C UT-S sensor: 0... +80 °C UTH-S sensor: -40... +130 °C
Ambient humidity	< 99 % rH
Storage temperature	-30 ... +70 °C
Transport temperature	-30 ... +70 °C
Pipe sizes	DN40 ... DN1200

## 5.5 Flow range

DN	DO	Max flow		
		l/min	m <sup>3</sup> /h	cfm
40	48	905	54	32
50	60	1,414	85	50
65	76	2,389	143	84
80	88	3,619	217	128
100	114	5,655	339	200
125	139	8,835	530	312
150	165	12,723	763	449
200	219	22,618	1,357	799
250	273	35,341	2,121	1,248
300	323	50,891	3,054	1,797
500	508	141,365	8,482	4,992
1,000	1,016	565,458	33,929	19,970
1,200	1,219	814,260	48,858	28,756

### Remarks:

DN: nominal inner diameter





DO: outer diameter (depends on standard and material)

## 6 Determination of installation point

To maintain the accuracy stated in the technical data, the ultrasonic transducers must be clamped on a straight pipe with unhindered flow characteristics. The pipe can be in vertical or horizontal position.

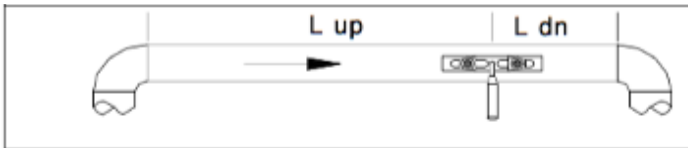
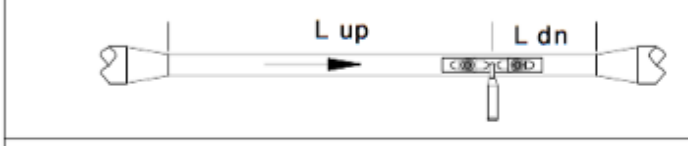
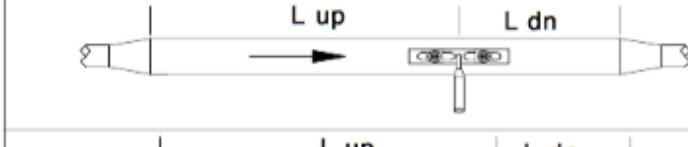
Unhindered flow characteristics are achieved if the section in front of the transducer (upstream) and behind the transducer (downstream) are sufficiently long, absolutely straight and free of obstructions such as edges, seams, curves, and so on.

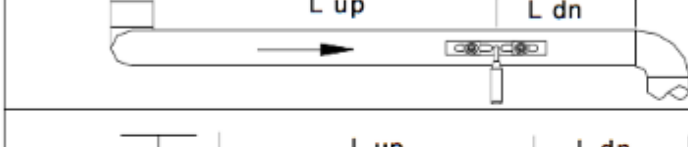
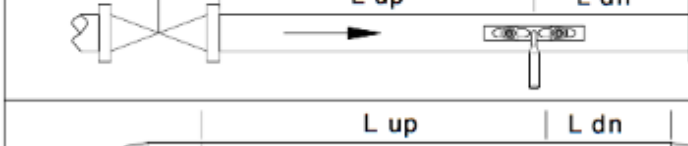
The following table shows examples of optimum installation locations.

Piping configuration and transducer position	Upstream dimension	Downstream dimension
	Lup x diameter	Ldn x diameter
	10D	5D
	10D	5D
	10D	5D
	12D	5D
	20D	5D
	20D	5D
	30D	5D

### Principles to select an optimum location:

- Install the transducers on a long straight pipe. The longer the better and make sure that the pipe is completely full of liquid.
- It's recommended to place the transducers not on top of the pipe, but rather at a side position to avoid air bubbles that may occur on top of the pipe can effect the measurement.
- Make sure that the temperature on the location does not exceed the permitted temperature range for the transducers. Generally, the closer to the room temperature the better.
- Take the pipe fouling into consideration. Select a straight and relatively new pipe. If the condition is not satisfying, consider the fouling thickness as part of the liner for a more accurate result.

### Remarks:

Some pipes have a kind of plastic liner. Between the outer pipe and the liner there may be a certain thickness difference that will prevent the ultrasonic waves from direct traveling. Such conditions will make the measurement impossible. Try to avoid this kind of pipes whenever possible.



### **ATTENTION!**

**Wrong measurement may occur if the transducers are not installed correctly.**

- The flow meter is for indoor use only! At an outdoor installation, the device must be protected from solar radiation and rain.
- It is strongly recommended not to install S461 permanently in wet environment.

## 7 Installation

Make sure that all components listed below are included in your package.

Qty	Description	Order No.
1	S461 Ultrasonic flow meter for liquids main unit <b>or</b> S461 Ultrasonic flow & energy meter for liquids main unit	D695 4610  D695 4611
1	UT-S, Ultrasonic transducer pair <b>or</b> UTH-S, Ultrasonic transducer pair	S695 4610  S695 4611
2	5 m connection cable to transducers	A553 0104
1	Metal stretchers	Depending on pipe diameter different P/N
1	Coupling agent	A695 4610
1	Instruction manual	N/A
1	S4C-US mobile App	To be downloaded from SUTO website

There are various options also available to choose from the following order table.

### Order table of the main unit mounting plate and output options

Order No.	Code	Description
Main unit mounting plate		
A4603	A	Pipe/Wall mounting plate (for pipe mounting please order metal stretcher separately)
A4604	B	35 mm DIN hat rail mounting plate
Output options		
	A	No further output
A4606	B	4 ... 20 mA, Pulse / Alarm
A4607	C	Modbus/TCP



### Order table of the temperature sensors

Order No.	Description
S693 4610	Temperature sensor pair, 5 m cable, M8 connector, -40 ... +130 °C, IP42
A4615	Sensor cable length extension (please inquire)

### Order table of accessories

Order No.	Description
A695 4601	Metal stretcher for sensor installation on pipes DN40 ... DN65 (2 pieces)
A695 4602	DN80 ... DN100 (2 pieces)
A695 4603	DN125 ... DN150 (2 pieces)
A695 4604	DN200 ... DN300 (2 pieces)
A695 4605	DN350 ... DN500 (2 pieces)
A695 4608	Belt stretcher for temporary sensor installations (portable unit), DN40 ... DN500 (2 pieces)
A695 4610	Coupling agent for sensor installation, 65 g
A554 4625	Transport casing S461 dimensions: 560 x 450 x 160 mm
A554 0107	Plug-in power supply, 100 ... 240 VAC / 24 VDC, 0.5 A , 1.5 m cable M12 connector. Recommended for portable unit.
A553 0154	Cable to connect power bank, 1.8 m, USB-C connector for power bank, M12 connector
A553 0104	Sensor cable, 5 m, with M12 connector, open wires, AWG24 (0.2 mm <sup>2</sup> )
A553 0105	Sensor cable, 10 m, with M12 connector, open wires, AWG24 (0.2 mm <sup>2</sup> )

### 7.1 Installing S461 main unit

1. Install the S461 main unit at the designated location. Through optional accessories it can be mounted on the wall, on the pipe or on a DIN hat rail.

Mounted on the wall

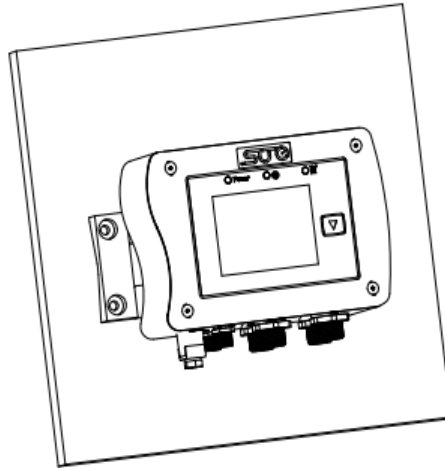

Mounted on the pipe

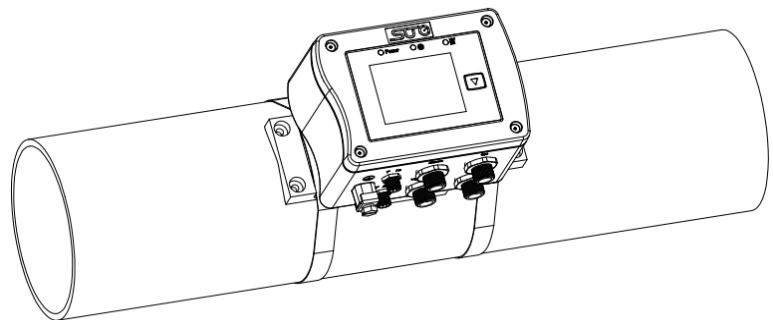

Mounted on a DIN hat rail

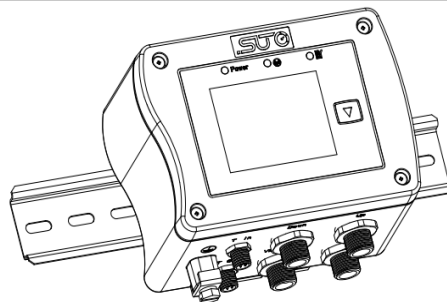

2. Connect the transducers, the power supply and temperature sensors to the designated connectors, as described in the table below.

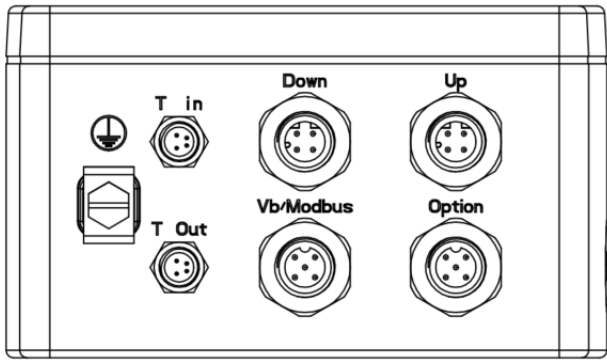

Connector arrangement

**Note:** When the S461 is used as a flow meter, there are no **T in** and **T out** connectors.

**T in:** Connect to the inlet temperature sensor.

**T out:** Connect to the outlet temperature sensor.

**Down:** Connect to the downstream transducer.

**Up:** Connect to the upstream transducer.

**Vb/Modbus:** Connect to the Modbus/RTU output/power supply.

**Option:** Connect to the Modbus/TCP output when it is a X-coded connector; connect to analog/pulse output when it is a A-coded connector.

- The S461 comes with an optional Earth connection, which is recommended to be used if the unit is operated in an environment with high electrical interference. The ⊕ terminal in the connector arrangement diagram is used for Earth connection.

## 7.2 Electrical connection

The S461 comes with four M12 connectors, two M8 connectors (for Flow and Energy meter).

### 7.2.1 M12 connection pins

The following table lists the types of the M12 connectors based on the outputs.

P/N	Output option	Connector type
A4606	4 ... 20 mA + Pulse	Option (Analog)= M12 (5-pole)
	Modbus/RTU	Vb/Modbus = M12 (5-pole)
A4607	Modbus/TCP	Option (TCP) = M12 (8-pole X-code)
		Down = M12 (4-pole)
S693 4610 NA		Up = M12 (4-pole)

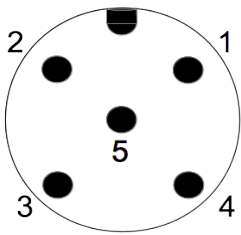

5-pole connector, male  
(View onto the sensor connector)

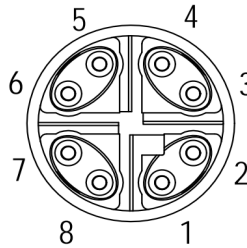

Ethernet connection, male  
(View onto the sensor connector)

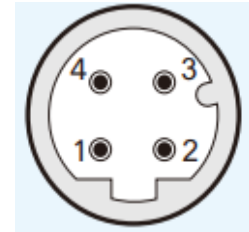

4-pole connector, male  
(View onto the sensor connector)

### M12 5-pole assignment

Output Type	Connector	Pin 1	Pin 2	Pin 3	Pin 4	Pin 5
4 ... 20 mA plus pulse (P/N: A4606)	Option (Analog)	NA	SW	SW	+I	-I
Modbus/RTU	Vb/Modbus	GND	-VB	+VB	D+	D-
Modbus/TCP (P/N: A4607)	Option (Modbus/TCP)	See section 7.2.2 on the next page.				
Color	/	Brown	White	Blue	Black	Grey

### Legend to pin assignment (M12 5-pole)

GND: Ground for Modbus/RTU	+P: Pulse output
-VB: Negative supply voltage	SW: Isolated pulse output
+VB: Positive supply voltage	D+: Modbus/RTU data +
+I: Positive 4 ... 20 mA signal	D-: Modbus/RTU data -
-I: Negative 4 ... 20 mA signal	NA: Not applicable

### M12 4-pole assignment

Connector	Pin 1	Pin 2	Pin 3	Pin 4
Down	DN+	NC	GND	DN-
Up	UP+	NC	GND	UP-

### Legend to pin assignment (M12 4-pole)

DN+:	DN sensor positive
DN-:	DN sensor negative
UP+:	UP sensor positive
UP-:	UP sensor negative
GDN:	Sensor GND
NC:	Not connected



#### **ATTENTION!**

**Do not screw the M12 connector using force. Otherwise it might damage the connecting pins.**

### 7.2.2 Ethernet connection

The S461 can be powered by the following ways:

- Using the connector Vb/Modbus.
- Using the PoE (Power over Ethernet) function, which is integrated into the Ethernet connection on connector Option(TCP).

To power the unit via PoE, a network switch that supports PoE is needed. PoE comes into two standards:

- Type A: The PoE switch powers the device via Pair 2 (Pin 1 and Pin 2) and Pair 3 (Pin 3 and Pin 6)
- Type B: The PoE switch powers the device via Pair 1 (Pin 4 and Pin 5) and Pair4 (Pin 7 and Pin 8)

This sensor supports both types.

### Connection cable – M12 X-coded to RJ45

When Modbus/TCP is chosen as the sensor output, a 5 m 8-pore cable is supplied in the delivery package. The has the M12 and RJ45 plugs on the ends. RJ45 is used to connect the sensor to a PoE switch.

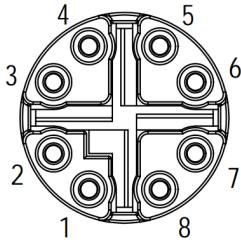
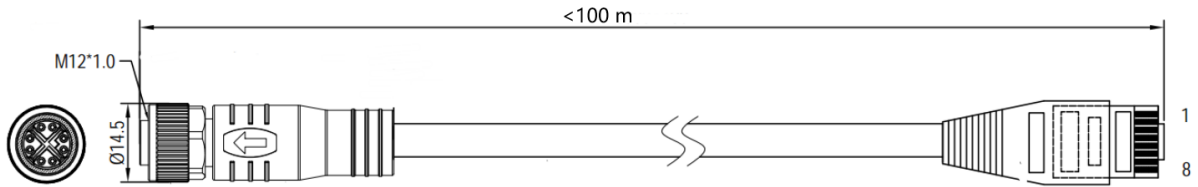

Front view of the M12 plug, female

The 8-position pin/pair assignment on the RJ45 side must comply with the T568B wiring method. The sensor does not support the T568A wiring method.

M12 X-code	RJ45	Signal	Color code	Pair designation
1	1	Tx+ / +Vb / -Vb	White-Orange (W-O)	Pair 2
2	2	Tx- / +Vb / -Vb	Orange (O)	
3	3	Rx+ / -Vb / +Vb	White-Green (W-G)	Pair 3
4	6	Rx- / -Vb / +Vb	Green (G)	
5	7	NA / -Vb	White-Brown (W-BR)	Pair 4
6	8	NA / -Vb	Brown (BR)	
7	5	NA/ +Vb	White-Blue (W-BL)	Pair 1
8	4	NA/ +Vb	Blue (BL)	

### 7.2.3 M8 connection pins

The S461 can be used as an energy meter. It comes with two M8 connectors: **T in** and **T out**, which connect to the inlet temperature sensor and outlet temperature sensor respectively. The temperature sensors (Pt1000) come with 5 m cable and M8 connector.

#### Pin assignment connector plug M8

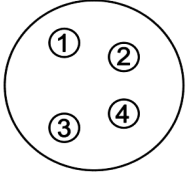
	Connector	Pin 1	Pin 2	Pin 3	Pin 4
	T in	PT1000	NC*	PT1000	NC*
	T out	PT1000	NC*	PT1000	NC*
Wire color		Red		Black	

\*NC: not connected



#### ATTENTION!

**Do not screw the M8 plug using force. Otherwise, it may damage the connecting pins.**

## 7.3 Setting S461 by S4C-US App

After the S461 is installed, power up it. Then follow the steps in sections 7.3.3 and 7.3.4 to start the mobile App S4C-US and set the parameters of the S461.

### 7.3.1 Installing S4C-US App

The S4C-US App is available for download on Apple Store, Google Play Store and the SUTO Website ([www.suto-itec.com](http://www.suto-itec.com)).

Use your mobile phone to download and install the application, same as you do for any other Apps.

### 7.3.2 Scanning QR code

To configure the S461, you must scan the QR code by using the S4C-US App to enable the configuration.

#### Preparation:

- Power on the S461.
- Obtain the QR code. The QR code is on the calibration certificate.

#### Steps:

1. Activate the **S4C-US** App on your mobile phone.
2. Click the **Scan QR Code** button.
3. Scan the QR code on the certificate.

After scanning the QR code, the S4C-US gets the S461 information, and the signal icon changes from **Orange** to **Green**, indicating that the S461 is configurable using the S4C-US.

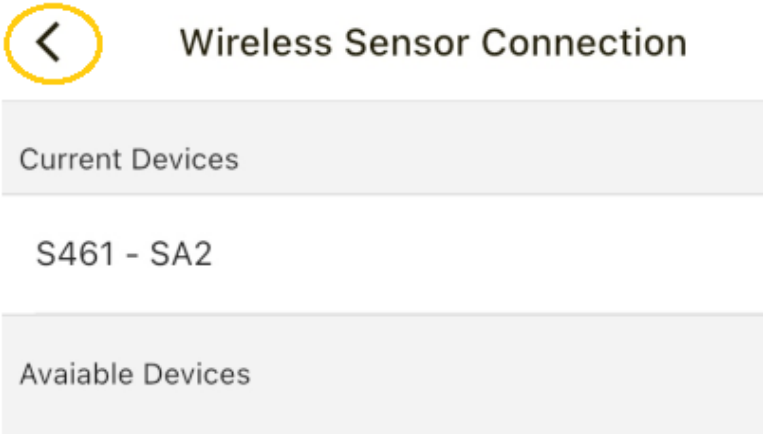
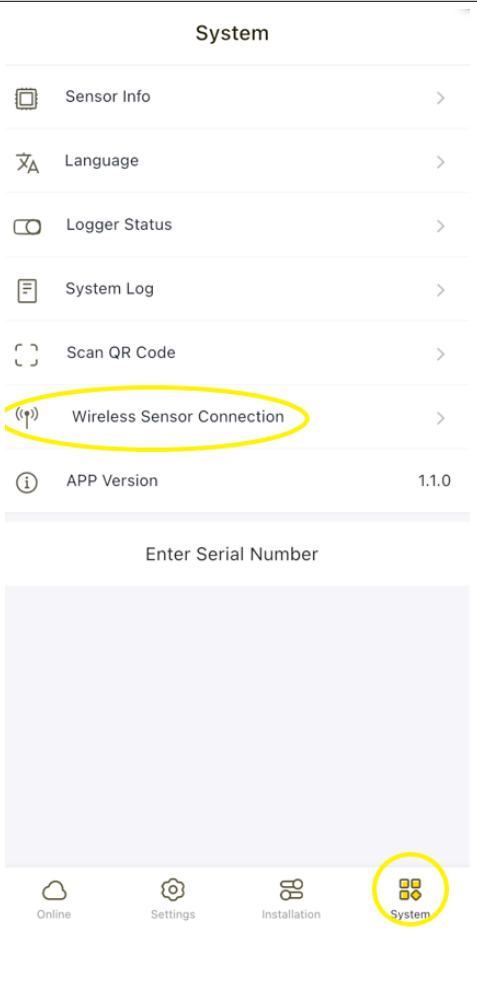

### 7.3.3 Basic Settings

Description	App view
<p>Follow the steps below to make the wireless connection with the S461.</p> <ol style="list-style-type: none"> <li>1. Tap on <b>System &gt; Wireless Sensor Connection</b>.</li> <li>2. Press as next the search icon.</li> </ol> <p>After a few seconds all S461 nearby will be listed with it's Serial Number as identifier.</p> <ol style="list-style-type: none"> <li>3. Select the unit which you want to connect to and finally the return arrow.</li> </ol> 	

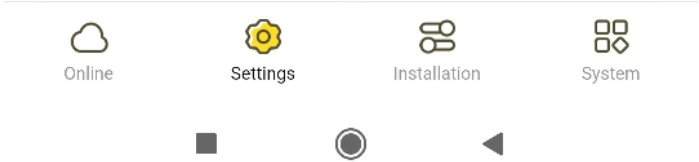
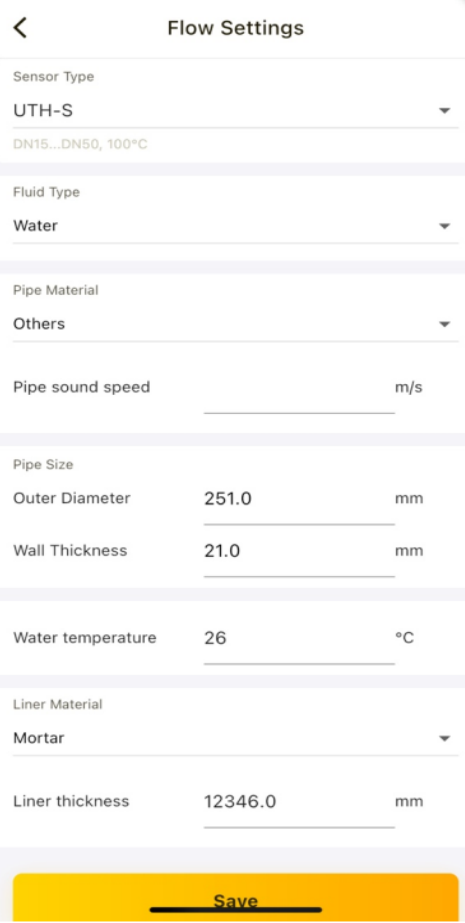
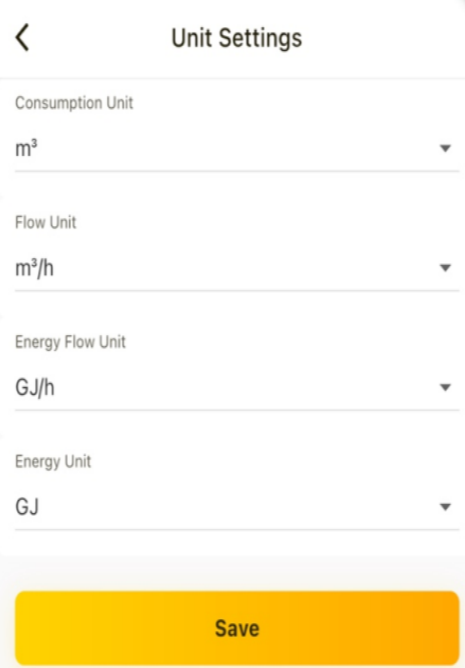
Description	App view
<p>4. Tap on the <b>Settings</b> for entering the basic settings:</p>  <p><b>Flow Settings:</b></p> <ul style="list-style-type: none"> <li>• Sensor Type UT-S (standard sensor) or UTH-S (high temperature sensor).</li> <li>• Fluid Type: fluid type to be measured.</li> <li>• Pipe material</li> <li>• Pipe sound speed</li> <li>• Pipe Size: outer diameter and wall thickness.</li> <li>• Water temperature: requires only a rough estimations as it has a slight effect on the transducer distance calculation.</li> <li>• Liner material</li> <li>• Liner thickness</li> </ul>	
<p>Under <b>Unit Settings</b> enter the desired physical units to be used. It can be chosen units for:</p> <ul style="list-style-type: none"> <li>• Consumption</li> <li>• Flow</li> <li>• Energy flow</li> <li>• Energy</li> </ul>	

### 7.3.4 Installation settings

Description	App view														
<p>Tab on the <b>Installation</b> to make the final settings and monitor the installation status.</p> <ol style="list-style-type: none"> <li>1. Select the <b>mounting method</b>:                     <ul style="list-style-type: none"> <li>• The <b>V</b> method is the standard method for pipe size below 200 mm.</li> <li>• The <b>Z</b> method is used for bigger pipes.</li> </ul> </li> <li>2. Select the <b>Installation Mode</b>: The default selection is "0". Other modes can be selected, if a good signal strength above 90% can not be achieved.</li> <li>3. Set the <b>Transducer spacing</b>. The transducer spacing is the distance of the two transducers when placing them on the pipe.</li> </ol>	<p>Installation</p> <p>Installation Type</p> <p>V</p> <p>L</p> <p>V is used for pipe &lt; 200 mm.</p> <p>Installation Mode</p> <p>3</p> <table border="1"> <tr> <td>Transducer spacing L</td> <td>15.9 mm</td> </tr> <tr> <td>Signal Quality SQ</td> <td>99 %</td> </tr> <tr> <td>Upstream Signal Strength</td> <td>88 %</td> </tr> <tr> <td>Downstream Signal Strength</td> <td>88 %</td> </tr> <tr> <td>Sound Velocity Ratio</td> <td>99 %</td> </tr> <tr> <td>Average Transmission Time</td> <td>100.99 US</td> </tr> <tr> <td>DeltaTime</td> <td>0.00 ns</td> </tr> </table> <p>Online Settings Installation System</p>	Transducer spacing L	15.9 mm	Signal Quality SQ	99 %	Upstream Signal Strength	88 %	Downstream Signal Strength	88 %	Sound Velocity Ratio	99 %	Average Transmission Time	100.99 US	DeltaTime	0.00 ns
Transducer spacing L	15.9 mm														
Signal Quality SQ	99 %														
Upstream Signal Strength	88 %														
Downstream Signal Strength	88 %														
Sound Velocity Ratio	99 %														
Average Transmission Time	100.99 US														
DeltaTime	0.00 ns														

## 7.4 Transducer Installation

This section describes procedures for installing and removing of the transducers.

The two transducers must be mounted on the pipes center line. On horizontal pipes at the side (not on top!) and on vertical pipes only of the flow direction is up!

### 7.4.1 Installing and removing the transducers

The alignment and the spacing of the transducers are critical factors for the measurement accuracy and the system performance.

Follow the steps for a proper installation:

1. Locate an optimum position where the straight pipe length is sufficient and the pipe is in a good condition. For example, a relatively new pipe with no rust and easy to operate.
2. Clean any dust and rust on the pipe surface.
3. Choose one of the two installation methods based on the pipe diameters.

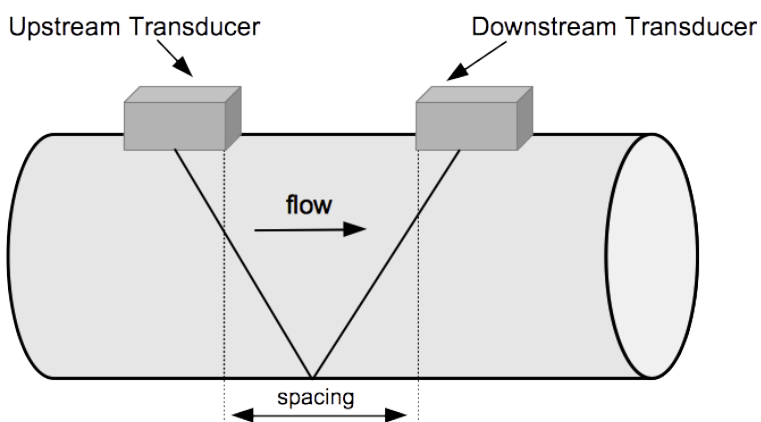

#### **V-Method:**

The transducers are mounted on the same side of the pipe and the sound crosses the pipe twice. It is commonly used when the pipe inner diameter ranging from 40 mm to 200 mm.

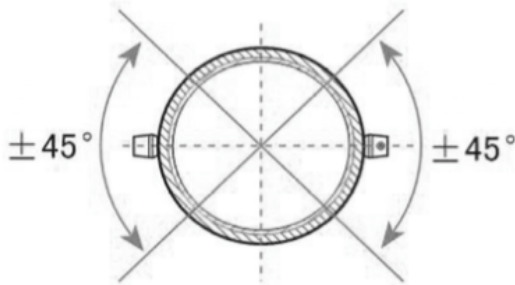
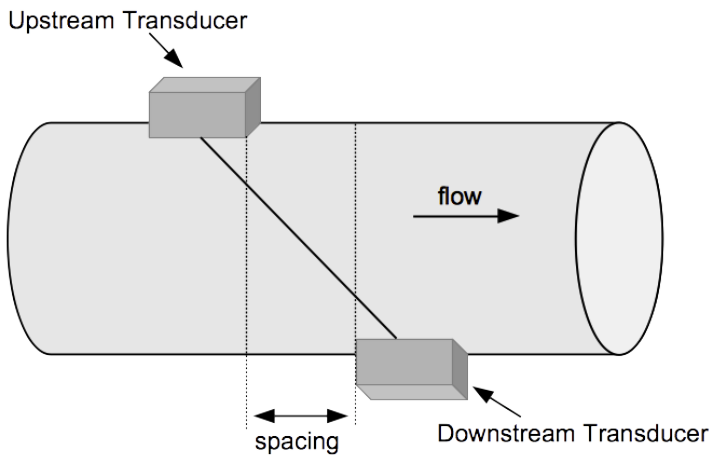
**Z-Method:**

The transducers are mounted on opposite sides of the pipe and the sound crosses the pipe once. It is commonly used when the pipe inner diameter is above 200 mm.

If the Z-Method is used, make sure that the transducers are mounted on a pipe within a valid angle range, as shown in the left picture.

4. Grease the underside of the transducers with the coupling agent.
5. Use the metal stretcher to attach a transducer on the pipe and leave no gap between the pipe surface and the transducer.

**ATTENTION!**

**The stretcher is under tension. Please open it carefully!**

6. Install the other transducer on the pipe as described in steps 4 and 5. Make sure that the distance between the two transducers is as close as possible to the "Transducer spacing" value shown on the mobile phone App.

**7.4.2 Removing a transducer**

Remove a transducer as described below.

1. Hold the transducer.
2. Release the metal stretcher.
3. Remove the coupling agent from the underside of the transducer.

## 7.5 Final check

After the complete installation of the transducers an installation check should be performed to ensure that the signal strength and signal quality of the transducers are in a valid range.

In the installation dialogue of the mobile app the parameters can be checked. Ensure that these parameters achieve the following valid values.

Parameter	Valid range	Unit
Signal Quality SQ	80.0 ... 99.0	%
Installation Status	R: Normal E: Error D: Adjusting Gain	
Upstream Signal Strength	80.0 ... 99.9	%
Downstream Signal Strength	80.0 ... 99.9	%
Sound Velocity Ratio	97 ... 103	%
Delta Time fluctuation	<20 %	ns

Here some recommendations if the parameters above are not within the valid ranges:

If the **Signal Strength** is not in the valid range, do the following:

- Relocate the transducers to a better position.
- Try to apply more coupling agents or clean the surface.
- Adjust position of the transducers vertically and horizontally while checking the varying signal strength and stop at the position of the highest signal strength.
- Check the transducers spacing to make sure the transducers spacing matches with the numbers shown in the mobile App.

If the **Signal Quality** is not in the valid range, do the following:

- Avoid interference from other instruments and devices such as a powerful working converter nearby. Try to relocate the flow meter to a new place where there is littler interference.
- Avoid bad sonic coupling for the transducers with the pipe. Try to apply more coupling agents or clean the surface.
- Relocate the transducers to a better position.
- Make an earth connection – there is an earth terminal at the S461.

If the **Sound Velocity Ratio** is not in the valid range, check the following to ensure:

- The parameters (pipe outside diameter, wall thickness, pipe material, liner, etc.) are entered correctly.
- The transducer mounting spacing is accordance with the value shown in the mobile App.
- The transducer is mounted at the pipe's center line on the same diameter.
- The scale is too thick or the pipe mounting is distorted in shape, etc.

The **Delta Time** is the best indication if the unit is running well. The fluctuation of the delta time should be less than 20%. If necessary check following:

- The pipe parameters are correctly entered.
- The actual spacing of the transducers is correctly placed and the same as displayed in the mobile app.
- The transducers are installed properly in the right directions.
- The mounting location is good and the pipe is not changed in shape or there is not too much fouling inside the pipes.
- Only when the pipe diameter is too small or velocity is too low can the fluctuation be wider.

The Installation Status can have following indications:

- **"R"** indicates that everything is normal.
- **"D"** indicates that the system is adjusting the signal gain prior to the measurement. This can be a normal situation, however when the adjustment takes too long without stopping, it can be considered as abnormal.
- **"E"** indicates that no signal is being detected. Check if the transducers are installed firmly, etc.

If an **"E" still** appears even after checking all settings and verifying the installation, please contact the manufacturer by sending screen shots from the installation screen and the flow settings.

## 7.6 Other Issues and recommended actions

Issue	Action
The display shows 0.00 for the flow rate while the flow inside the pipe is not zero.	Use the "Remove Zero Calibration" function on under the "Zero Calibration" menu on the mobile app. Check the <b>Cut-Off Velocity</b> setting under the Factory Settings.
The display shows a much higher or lower flow rate than the actual one.	Check if the transducer is correctly installed. Zero calibrate the instrument by using "Zero Flow Calibration" and make sure that the flow inside the pipe is zero.

## 8 Other settings

### 8.1 Factory settings

#### 8.1.1 Fixed delay

Default setting is "0" and setting ex factory can only be changed with special authorization.

Only the SUTO service people can apply for the special authorization by contacting SUTO Service Team.

#### 8.1.2 User calibration factor

Is a factor that will manipulate the flow reading:  $\text{Reading} = \text{measured value} * \text{Factor}$ . This can only be changed with special authorization.

#### 8.1.3 Cut-Off velocity

Velocity measured below this setting will be displayed as zero.

Recommended setting is 0.03 m/s.



### 8.1.4 Bi-directional flow

When this parameter is activated the velocity and flow rates are displayed as negative value if a reverse flow is detected. There are separate consumption counters for forward and reverse direction.

### 8.1.5 Delta T Cut-Off

For the energy meter version if a Delta T below this setting is measured it will be displayed as zero.

## 8.2 Totalizer settings

There are 3 different totalizers in the instrument accumulating the consumption of Flow, Heat and Cold. Each of these totalizers can be reset to zero. This function requires special authorization.

## 8.3 Alarm settings

Alarm monitoring can be activated. If the Analog/Alarm option is integrated in the instrument a relay output is activated on alarm. If not, the alarm indication is on the local display and on the mobile app in the online window to be seen.

## 8.4 Output settings

By default the S461 comes with Modbus/RTU interface and can be additionally equipped with either Modbus/TCP or Analog / Pulse / Alarm.

### 8.4.1 Modbus output

#### Modbus/RTU and Modbus/TCP output table

Parameter	Description	Settings
Address	Set the device address. Each device must have a unique device address.	1 ... 247 Default: 1
Baudrate	Select a baud rate.	- 1200 - 2400 - 4800 - 9600 - <b>19200</b> (default) - 38400 - 57600 - 115200

Parity/Framing	Select the parity, framing and stop bit.	<ul style="list-style-type: none"> <li>- 8,E,1</li> <li>- 8,O,1</li> <li>- 8,N,2</li> <li>- <b>8,N,1</b> (default)</li> </ul>
----------------	--	---

**Note:** All devices on the bus must have the same communication parameters: baud rate, parity, stop bit.



### 8.4.2 Analog output

Parameter	Description	Settings
Channel	Select the channel type.	<ul style="list-style-type: none"> <li>- Flow</li> <li>- <b>Velocity</b> (default)</li> <li>- Heat power</li> </ul>
Scaling type	<p>Select the scaling type.</p> <p><b>Fixed:</b> indicates the output is scaled from 0 ... 12 m/s which is equal to 0 ... max flow, and cannot be modified.</p> <p><b>Variable:</b> indicates the output is scaled from 0 ... 12 m/s which can be equal to a configurable flow.</p>	<ul style="list-style-type: none"> <li>- <b>Fixed</b> (default)</li> <li>- Variable</li> </ul>

### 8.4.3 Pulse output

Parameter	Description	Settings
Channel	Select the channel type.	<ul style="list-style-type: none"> <li>- <b>Forward consumption</b>(default)</li> <li>- Reverse consumption</li> <li>- Heat energy</li> </ul>
Pulse Per Unit	<p>Select how many units of consumption a pulse is equivalent to.</p> <p>Example: <b>1 pulse per 10</b> indicates that one pulse is equivalent to 10 units of consumption.</p>	<ul style="list-style-type: none"> <li>- Deactivated</li> <li>- <b>1 pulse per 1</b> (default)</li> <li>- 1 pulse per 10</li> <li>- 1 pulse per 100</li> </ul>

#### 8.4.4 Alarm output

Parameter	Description	Settings
Alarm setting	Indicate if the alarm is enabled or disabled.	 : <b>disabled</b>  : <b>enabled</b>
Alarm	Indicate using flow or velocity to set alarm threshold.	- Flow - <b>Velocity</b> (default)
Low alarm	The threshold and hysteresis are used to activate or deactivate the alarm. When the flow or velocity is lower than the threshold, the low alarm is activated. When the flow or velocity is higher than the (threshold + hysteresis), the low alarm is deactivated.	Default threshold=0  default hysteresis=1
High alarm	When the flow or velocity is higher than the threshold, the high alarm is activated. When the flow or velocity is lower than the (threshold - hysteresis), the high alarm is deactivated.	Default threshold=0  default hysteresis=1

## 8.5 Calibration

To access the Calibration functions a special authorization is required.

Only the SUTO service people can apply for the **Calibration** authorization by contacting SUTO Service Team.

### 8.5.1 Zero flow calibration

It is used to remove and to perform a zero flow calibration. When doing the zero flow calibration please ensure that there is no flow in the pipe!

### 8.5.2 T-Offset calibration

This function is available for the Energy Meter version. It can be used to to adjust the temperature readings through an offset.

### 8.5.3 User calibration

This function can be used to adjust the flow meter at up to 5 calibration points in a third party flow lab.

## 8.6 Logger settings

Through this function the internal data logger is activated and the recording interval is set. It will always record all available measuring channels. The recordings can be read out through OTG memory stick, through the mobile app or through the PC software S4A.

## **9 System Functions**

### **9.1 Sensor info**

It shows details of the device such as Serial Number, calibration Date, Hardware version etc. Please make a screen shot in case of any technical inquiries.

### **9.2 Language**

It is used to select the user interface language.

### **9.3 Logger status**

Shows the logger status with start and end date and number of recordings.

### **9.4 System log**

For internal use. Take a copy and send it to SUTO customer service in case of technical inquiries.

### **9.5 Wireless sensor connection**

It is used to make a wireless connection to S461.

### **9.6 App version**

It shows the installed version number.

## 10 Calibration

In certain installations the display will show a non-zero flow even if there is absolutely no flow. In this case, a zero point calibration is recommended. Make sure that there is zero flow in the pipe before activating this function in the sensor menu.

The sensor is calibrated ex work. The exact calibration date is printed on the certificate which is supplied together with the sensor. The accuracy of the sensor is regulated by the on site conditions, parameters like oil, high humidity or other impurities can affect the calibration and furthermore the accuracy. However we recommend to calibrate the instrument at least once per year. The calibration is excluded from the instruments warranty. For this please contact the manufacturer.

## 11 Maintenance

To clean the flow meter and its accessories it is recommended to use moist cloth only.



### **ATTENTION!**

**Do not use isopropyl alcohol to clean the display!**

## 12 Disposal or waste



Electronic devices are recyclable material and do not belong in the household waste.

The device, the accessories and its packing must be disposed according to your local statutory requirements. The dispose can also be carried by the manufacturer of the product. Please contact the manufacturer for details.

## **13 Appendix – Modbus register table**

The Modbus register table can be downloaded from: [https://www.suto-itec.com/content/downloads/SUTO\\_IM/UK/S461\\_Modbus\\_Register\\_Table\\_2021-1.pdf](https://www.suto-itec.com/content/downloads/SUTO_IM/UK/S461_Modbus_Register_Table_2021-1.pdf).

---

**SUTO iTEC GmbH**

Grißheimer Weg 21  
D-79423 Heitersheim  
Germany

Tel: +49 (0) 7634 50488 00  
Fax: +49 (0) 7634 50488 19  
Email: [sales@suto-itec.com](mailto:sales@suto-itec.com)  
Website: <http://www.suto-itec.com>

**SUTO iTEC (ASIA) Co., Ltd.**

Room 10, 6/F, Block B, Cambridge Plaza  
188 San Wan Road, Sheung Shui, N.T.  
Hong Kong

Tel: +852 2328 9782  
Fax: +852 2671 3863  
Email: [sales@suto-itec.asia](mailto:sales@suto-itec.asia)  
Website: <http://www.suto-itec.com>

---

All rights reserved ©

Modifications and errors reserved

S461\_im\_en\_2021-1

---